

# HYDROPOOL self-cleaning hot tubs owner's manual



**HYDROPOOL**  
the self-cleaning hot tub



Intertek  
99399

HydroPool Inc.:  
Tel: 905.565.6810  
Toll Free: 1.800.465.2933  
Fax: 905.565.6820  
Email: [info@hydropoolhottubs.com](mailto:info@hydropoolhottubs.com)  
[www.hydropoolhottubs.com](http://www.hydropoolhottubs.com)

BJAD

Please visit [www.hydropoolhottubs.com](http://www.hydropoolhottubs.com)  
to register your hot tub and activate your  
warranty with 30 days of the date of delivery.

## TABLE OF CONTENTS

<b>Letter of introduction</b>	3	<b>Jet and Feature Operation</b>	
<b>Important User Safety Instructions</b>		Jet Identification Chart	29
Warnings	4	Jet Water Flow Adjustment	29
Hyperthermia	5	Jet Air Flow Adjustment	29
<b>Choosing the Right location</b>		Interchanging Jet Inserts	29
Indoor Locations	6	Cleaning Stainless Steel Jets & Controls	29
Outdoor Locations	6	Cleaning Optional Cascading Waterfall Jets	29
<b>General Installation Considerations</b>	7	Optional Acupressure Sequence Massage Filter	29
<b>Special Considerations</b>		Removal and Replacement	30
Indoor Installations	7	Diverter Valve	30
Outdoor Installations	7	Waterfall Control (optional)	30
<b>Site Preparation</b>		Hydropool Surround Sound Audio/Docking Station	31
Above Ground Installations	8	Docking Your Audio Device	31
In-ground & Partial In-ground Installations	8	Hydropool Surround Sound Stereo Receiver	31
Overall Support (non-cabinet installations)	8	Radio Operation	32
<b>Equipment Accessibility &amp; Protection</b>	9	USB Operation	33
<b>Remote Equipment Placement</b>	9	General Controls	34
<b>Unloading/Handling your Hot Tub</b>	9	<b>Hot Tub Water Balance</b>	
<b>Important Electrical Safety Instructions</b>	10	General Overview	35
G.F.C.I./R.C.D. Application Guideline & Wire Size	10	Initial Fill	35
North America G.F.C.I. Installation Diagram	11	Glossary of Common Water Maintenance Terms	36
Europe R.C.D. Installation Diagram	12	Water Balance Summary for your Hot Tub (chart)	36
<b>Accessories</b>		Water Balance Troubleshooting	37
Waterfall Pillows	13	<b>Routine Hot Tub Maintenance</b>	
Filter/Ice Bucket Lids	13	Daily, Weekly, Monthly, Quarterly	38
Safety Hardcover Locks	13	Cleaning the Skimmer Basket	38
Dream Scents Aromatherapy System (optional)	13	Cartridge Filter, Removal, Cleaning, Re-installation	39
Cover Remover (optional)	13	Cleaning the Acrylic Surface	39
Ozone (optional)	13	Safety Hard Cover	39
Steps (optional)	14	Changing your Hot Tub Water	40
Rowing Kit (optional for 1038 only)	14	Draining your Hot Tub Water	40
I-Command System (optional)	14	<b>Hydropool Exclusive Quick-Drain™ Self-Cleaning Mode Indicator</b>	41
<b>Filling, Checking and Starting your Hot Tub</b>	15-16	<b>Wood Products</b>	
Pump Priming/Releasing an Air Lock	15-16	Cabinet Wing-Locks	42
<b>Hydropool Control Systems</b>	17-27	Protecting your Cabinet Wood Finish	42
IN.XE Spa Pack Series	17-21	<b>Winterizing your Hydropool Hot Tub</b>	43
IN.XM Spa Pack Series	22-26	<b>General Troubleshooting</b>	44
Hydrother Control / Wellness Package (optional)	27	What to do in the event of	
<b>Topside Panel Display Messages</b>	28	Power Fluctuations	44
<b>Optional Variable Air Therapy System</b>	28	Cold Weather Power Failure	44

**NOTE: Product specifications, warnings and labels are subject to change without notice. This user's manual should be used as a guide only. For further information, please contact your independent Hydropool dealer.**

On behalf of everyone at the company, we thank you for your decision to purchase a HydroPool hot tub.

Recognized for quality worldwide, we are confident that your new hot tub will provide you, your family and friends, with years of enjoyment and fulfill all your hydrotherapy needs.

HydroPool hot tubs are not only healthful and relaxing, they can even add value to your home.

**Please take the time to carefully read and understand all the safety, installation and operating instructions in this manual before electrically connecting your hot tub and adding water.**

The following pages contain valuable information and pointers that will save you both time and money, as well as help you to simplify upkeep and maintenance.

Since we manufactured our first hot tub in 1985, the HydroPool team has been dedicated to producing a quality product catering to maximum hydrotherapy, comfort, energy efficiency and ease of operation.

We are confident that as you become more familiar with the various safety and maintenance features of your new hot tub you will be satisfied that you made the right decision in purchasing a HydroPool hot tub.

**Happy hot tubbing...**



**David Jackson**



## SAVE THESE INSTRUCTIONS

### IMPORTANT SAVE THESE INSTRUCTIONS

Your physiological response to hot water is subjective and depends on your age, health, and medical history. If you don't know your tolerance to hot water, or if you get a headache, or become dizzy or nauseous when using your hot tub, get out and cool off immediately.



# WARNING

1. CHILDREN SHOULD NOT USE SPAS OR HOT TUBS WITHOUT ADULT SUPERVISION.
2. DO NOT USE SPAS OR HOT TUBS UNLESS ALL SUCTION GUARDS ARE INSTALLED TO PREVENT BODY AND HAIR ENTRAPMENT.
3. PEOPLE USING MEDICATIONS AND/OR HAVING ANY ADVERSE MEDICAL HISTORY SHOULD CONSULT A PHYSICIAN BEFORE USING A SPA OR HOT TUB.
4. PEOPLE WITH INFECTIOUS DISEASES SHOULD NOT USE A SPA OR HOT TUB.
5. TO AVOID INJURY, EXERCISE CARE WHEN ENTERING OR EXITING THE SPA OR HOT TUB.
6. DO NOT USE DRUGS OR ALCOHOL BEFORE OR DURING THE USE OF A SPA OR HOT TUB, TO AVOID UNCONSCIOUSNESS AND POSSIBLE DROWNING.
7. PREGNANT OR POSSIBLE PREGNANT WOMEN SHOULD CONSULT A PHYSICIAN BEFORE USING A SPA OR HOT TUB.
8. WATER TEMPERATURE IN EXCESS OF 38°C (100°F) MAY BE INJURIOUS TO YOUR HEALTH.
9. BEFORE ENTERING THE SPA OR HOT TUB, MEASURE THE WATER TEMPERATURE WITH AN ACCURATE THERMOMETER.
10. DO NOT USE A SPA OR A HOT TUB IMMEDIATELY FOLLOWING STRENUOUS EXERCISE.
11. PROLONGED IMMERSION IN A SPA OR HOT TUB MAY BE INJURIOUS TO YOUR HEALTH.
12. DO NOT PERMIT OR USE ELECTRIC APPLIANCES (SUCH AS LIGHT, TELEPHONE, RADIO OR TELEVISION) WITHIN 1.5M (5FT) OF THIS SPA OR HOT TUB.
13. CHILDREN SHOULD NOT ENTER A HOT TUB WHERE THE WATER TEMPERATURE EXCEEDS BODY TEMPERATURE (37°C / 98.6°F).
14. DO NOT ALLOW CHILDREN TO SUBMERGE THEIR HEAD UNDER WATER.
15. NEVER OPERATE THE HOT TUB PUMP AT HIGH SPEED WITHOUT HAVING ALL SUCTION AND RETURN LINES OPEN.
16. ALWAYS KEEP THE HARDCOVER INSTALLED AND LOCKED WHEN THE HOT TUB IS NOT IN USE.
17. TEST THE GFCI (GROUND FAULT CIRCUIT INTERRUPTER) MONTHLY.
18. POST EMERGENCY PHONE NUMBERS FOR POLICE, FIRE DEPARTMENT, AND AMBULANCE AT THE NEAREST PHONE.
19. TO REDUCE THE RISK OF INJURY
  - THE WATER IN A SPA SHOULD NEVER EXCEED 40°C (104°F). WATER TEMPERATURES BETWEEN 38°C (100°F) AND 40°C (104°F) ARE CONSIDERED SAFE FOR A HEALTHY ADULT. LOWER WATER TEMPERATURES ARE RECOMMENDED FOR YOUNG CHILDREN AND WHEN SPA USE EXCEEDS 10 MINUTES.
  - SINCE EXCESSIVE WATER TEMPERATURES HAVE A HIGH POTENTIAL FOR CAUSING FETAL DAMAGE DURING THE EARLY MONTHS OF PREGNANCY, PREGNANT OR POSSIBLY PREGNANT WOMEN SHOULD LIMIT SPA WATER TEMPERATURES TO 38°C (100°F).
  - BEFORE ENTERING A SPA, THE USER SHALL MEASURE THE WATER TEMPERATURE SINCE THE TOLERANCE FOR WATER TEMPERATURE-REGULATING DEVICES VARIES.
  - THE USE OF ALCOHOL, DRUGS, OR MEDICATION BEFORE OR DURING SPA USE MAY LEAD TO UNCONSCIOUSNESS, WITH THE POSSIBILITY OF DROWNING.
  - OBESE PERSONS AND PERSONS WITH A HISTORY OF HEART DISEASE, LOW OR HIGH BLOOD PRESSURE, CIRCULATORY SYSTEM PROBLEMS OR DIABETES SHOULD CONSULT A PHYSICIAN BEFORE USING A SPA.
  - PERSONS USING MEDICATION SHOULD CONSULT A PHYSICIAN BEFORE USING A SPA SINCE SOME MEDICATION MAY INDUCE DROWSINESS WHILE OTHER MEDICATION MAY EFFECT HEART RATE, BLOOD PRESSURE AND CIRCULATION.

## SAVE THESE INSTRUCTIONS

### IMPORTANT SAVE THESE INSTRUCTIONS

Your physiological response to hot water is subjective and depends on your age, health, and medical history. If you don't know your tolerance to hot water, or if you get a headache, or become dizzy or nauseous when using your hot tub, get out and cool off immediately.



# CAUTION

1. MAINTAIN WATER CHEMISTRY IN ACCORDANCE WITH THE MANUFACTURER'S INSTRUCTIONS.



# DANGER

1. RISK OF ACCIDENTAL DROWNING. EXTREME CAUTION MUST BE EXERCISED TO PREVENT UNAUTHORIZED ACCESS BY CHILDREN. TO AVOID ACCIDENTS, ENSURE THAT CHILDREN CAN'T USE THE SPA UNLESS THEY ARE SUPERVISED AT ALL TIMES.
2. RISK OF INJURY. THE SUCTION FITTINGS IN THIS SPA ARE SIZED TO MATCH THE SPECIFIC WATER FLOW CREATED BY THE PUMP. SHOULD THE NEED ARISE TO REPLACE THE SUCTION FITTINGS OR THE PUMP, BE SURE THAT THE FLOW RATES ARE COMPATIBLE. NEVER OPERATE THE SPA IF THE SUCTION FITTINGS ARE BROKEN OR MISSING. NEVER REPLACE A SUCTION FITTING WITH ONE RATED LESS THAN THE FLOW RATE MARKED ON THE ORIGINAL SUCTION FITTING.
3. RISK OF ELECTRIC SHOCK. INSTALL AT LEAST 1.5M (5FT) FROM ALL METAL SURFACES. AS AN ALTERNATIVE, A SPA MAY BE INSTALLED WITHIN 1.5M (5FT) OF METAL SURFACES IF EACH METAL SURFACE IS PERMANENTLY CONNECTED BY A MINIMUM 8 AWG (8.4 mm<sup>2</sup>) SOLID COPPER CONDUCTOR TO THE WIRE CONNECTOR ON THE TERMINAL BOX THAT IS PROVIDED FOR THIS PURPOSE.
4. RISK OF ELECTRIC SHOCK. DO NOT PERMIT ANY APPLIANCE, SUCH AS A LIGHT, TELEPHONE, RADIO, OR TELEVISION, WITHIN 1.5M (5FT) OF THE SPA.

### **HYPERTHERMIA**

Since your hot tub can be set to reach temperatures of 40°C (104° F), users should be aware that extended submersion in water that exceeds normal body temperature can lead to hyperthermia.

The causes, symptoms and effects of hyperthermia may be described as follows:

Hyperthermia occurs when the internal temperature of the body reaches several degrees above the normal body temperature of 37°C (98.6°F). The symptoms of hyperthermia include drowsiness, lethargy, and an increase in the internal temperature of the body. The effects of hyperthermia include:

- Unawareness of impending hazard
- Failure to perceive heat
- Failure to recognize the need to exit the hot tub
- Physical inability to exit the hot tub
- Fetal damage in pregnant woman
- Unconsciousness resulting in the danger of drowning

If you sense any of the symptoms of hyperthermia, safely exit the hot tub immediately.

## WARNING



THE USE OF ALCOHOL, DRUGS OR MEDICATION CAN SIGNIFICANTLY INCREASE THE RISK OF FATAL HYPERTHERMIA.

## CHOOSING THE RIGHT LOCATION

Your HydroPool hot tub can be installed indoors or out, on the ground, in the ground or half-and-half. The following information will assist you in choosing the right location for your individual needs. When making your decision, always remember that hot tubs can be enjoyed year-round, indoors or out, regardless of the climate. Many HydroPool owners report that their favourite time to use a hot tub is in the cooler fall and winter months, while others praise the enjoyment of using their hot tub in the warmer spring and summer months.

### INDOOR LOCATIONS

If members of your family are not cold weather enthusiasts, or if your backyard or patio area is not suitable for a hot tub installation, then an indoor location for your hot tub may be your best or only choice. You may wish to create an exercise/spa area in your home, or install your hot tub in a glass solarium or four-season room adjoining your home. Indoor installations not only add a unique look and appeal to your home, they provide the privacy and controlled climate to ensure that use and enjoyment of your hot tub is maximized. If you should choose an indoor location, you will find further information as outlined in the section “**SPECIAL CONSIDERATIONS FOR INDOOR INSTALLATIONS**”



### OUTDOOR LOCATIONS

For a variety of reasons, outdoor locations are a far more popular choice. Some of the reasons include:

- Limited indoor space
- Delivery complications due to door openings, stairwells, etc.
- Limited budget (indoor installations usually also involve interior home renovations)
- Desire for an outdoor entertainment center
- Hot tub is being installed adjacent to an existing or planned swimming pool
- Concerns over splashing water inside the home

For those who choose an outdoor location, hot tub operating temperatures can be adjusted to match the season. In colder months, many owners will operate their hot tub in the range of 38-40°C (100 -104°F). During warmer months, an operating temperature of 36-37°C (97-99°F) will provide a refreshing retreat. If you should choose an outdoor location, you will find further information as outlined in the section “**SPECIAL CONSIDERATIONS FOR OUTDOOR INSTALLATIONS**”



## GENERAL INSTALLATION CONSIDERATIONS

- 1 Your HYDROPOOL hot tub is a self-contained pre-plumbed unit, so that no on-site plumbing connections to the residential water supply or drain are required.
- 2 Ensure that your HYDROPOOL hot tub is properly supported by either a level concrete pad, or a properly constructed deck capable of supporting 1220 kg/m<sup>2</sup> (250 lbs./ft.<sup>2</sup>). If there is a possibility that the pad could shift by freezing/thawing ground movement (such as in clay regions, and/or areas with high water tables) concrete footings extending below the frost line are recommended.
- 3 Decking should be chosen and constructed in a manner that minimizes the chance of slipping or falling.
- 4 If you do not have a factory installed insulated cabinet, it is assumed that you are building your own custom cabinet, tiling or decking.

**Please consider the following:**

- a Your HYDROPOOL hot tub is self-supporting on its base. The cabinet should be decorative only, not for support. Never suspend the hot tub from the deck or cabinet.
- b Where the hot tub is not equipped with a factory installed cabinet, it is the installer's responsibility to ensure all electrical equipment is **completely weather protected** and meets all of the regulatory requirements.

- c Always provide adequate access for servicing the support equipment.
  - d Decking should be constructed to allow repair access around the entire hot tub.
  - e In remote equipment or no-cabinet installations, you may add extra insulation, but the equipment area must have adequate cross-flow ventilation.
- 6 Installation of a safety grab rail or reachable support for use when entering or exiting the hot tub is recommended.
  - 7 A nearby garden hose connection is recommended for filling and "topping up" the hot tub.

### WARNING



The hot tub equipment and all electrical plugs, outlets and lights within 1.5m (5ft) of the hot tub must be G.F.C.I protected. Consult your electrician or local electrical authority for further details.

**Access to the hot tub must always be secured:**

**Outdoors - in accordance with local property by-laws and/or via an approved fence with a self-closing gate and a safety hardcover;**

**Indoors - by a lockable door and a safety hardcover.**

## SPECIAL CONSIDERATIONS

### INDOOR INSTALLATIONS

- It is beneficial to have the hot tub room located near washroom and shower facilities
- The hot tub room should have a floor drain to handle splash water, a window, outside exhaust fan or humidistat controlled exhaust fan for ventilation and a humidifier.
- Consider plumbing a water tap and drain location nearby to facilitate draining and top-up
- Always provide adequate ventilation for the support equipment
- Consult your local Hydropool retailer for further information

### OUTDOOR INSTALLATIONS

- Contact your local building code department to determine if a building permit is necessary and for information on applicable bylaws (distance from property lines, buildings, fencing requirements, etc.)
- If you are doing any excavating, contact your local gas, electric, and cable-company to ensure that there are no underground lines
- Locate the hot tub, where practical, within close distance of a door to the house to maximize potential winter use.
- Ensure that all hot tub support equipment is easily accessible and protected from the elements
- The hot tub support equipment is designed for indoor (out of the direct elements) use. When your HYDROPOOL hot tub is equipped with a factory-installed cabinet, and installed as per the guidelines of this manual, the equipment will be adequately protected. If the hot tub is shipped without a cabinet, your custom cabinet or other structure must be designed to supply protection for the hot tub support equipment from rain, snow, splash water, etc., but still designed in a manner to ensure adequate ventilation.

## SITE PREPARATION

### ABOVE-GROUND INSTALLATIONS

Where the hot tub is a “stand-alone” above-ground installation to be installed in regions where freeze/thaw conditions may occur, a level patio stone or pre-formed paver type base may be sufficient if there is no abutting deck(s) that could be damaged during potential seasonal movement of the ground. The potential drawback to this type of base is that splash water could eventually de-stabilize the ground under the base, with the resultant shift of the support base causing damage to the hot tub structure.

For best results, we recommend the installation of a level concrete pad:

- **Dig out and level the ground 20-30 cm (8-12 in.) below your desired base level**
- **Install 10-15 cm (4-6 in.) of crushed stone**
- **Next, install 10-15 cm (4-6 in.) of poured concrete**
- **Level the concrete and apply a broom-type finish**
- **We recommend that the pad be made 15 cm (6 in.) larger than the hot tub on three sides, and 1 m (3 ft.) larger on the side where the access steps and/or planters will be installed.**
- **Hot tub/swimspa must be installed on a level pad**

In regions where freeze/thaw occurs, or where there will be custom decking abutting the hot tub we recommend the installation of sono-tubes beneath the pad to prevent shifting.

### IN-GROUND & PARTIAL IN-GROUND INSTALLATIONS

For units being installed fully or partially in the ground, the type of support will again vary based on whether or not the tub is being installed in an area with freeze/thaw conditions. Hydro-pool does **not** recommend back-filling full in-ground or partial in-ground installations.

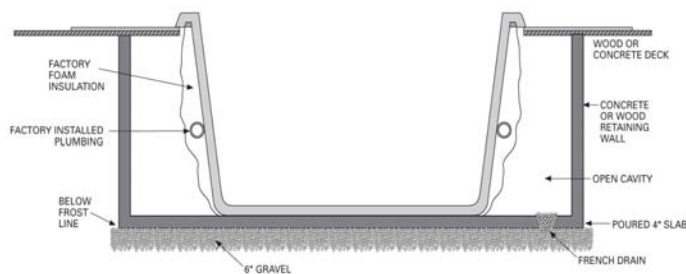

• Non-freezing climates – it is sufficient to ensure that the base of the hole or cavity created for the tub has a dry, stable, compacted level base and proper drainage.

• Climates where freeze/thaw occurs – it is necessary that a poured level reinforced concrete base, complete with concrete footings, be installed as outlined in the section **ABOVE-GROUND INSTALLATIONS**.

Areas with a high ground water table – a level concrete base, as well as a concrete or wood retaining wall to hold back the earth, is recommended. This forms a box or ‘bunker’, in which the hot tub is placed.

• **ALWAYS** ensure that there is good drainage, via a properly designed French drain (gravel) system and/or a sump pump, to prevent ground water flooding damage to the support equipment or hot tub structure.

• Install protective waterproof conduit to house any cables that will be buried.

• Access for future service must be considered at the time of design and installation. You must be able to access all sides and areas of your hot tub. Difficult access will result in supplemental service labor charges not covered by the factory warranty.

Consider easily removable deck materials.

• Make sure the hot tub or swim spa is tested for 48 hours before you prepare the installation of the surrounding/finish deck around your hot tub. Even though all units are tested in our plant, some transport/site handling damage can occur and we suggest you make sure the tub is perfectly waterproof before finalizing your installation.

### OVERALL SUPPORT (non-cabinet installations)

Your Hydro-pool hot tub is equipped with a factory installed load support substructure, which distributes the weight of the water over the entire foot area of the hot tub. The cabinet, either factory installed or customized on-site, should be decorative only, and not relied on for overall support. Although the lip of the hot tub must be supported to ensure it remains level, never suspend a hot tub from a deck or floor by the outer acrylic edge, as this will lead to product damage and/or serious personal injury.

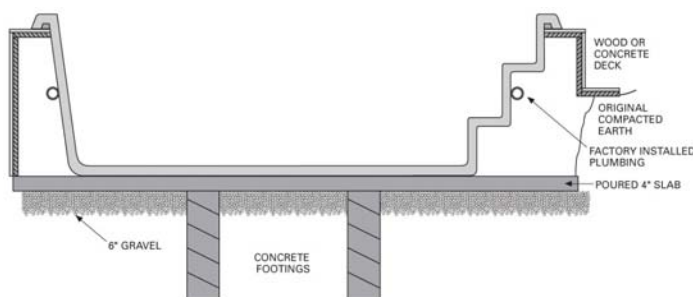



## EQUIPMENT ACCESSIBILITY AND PROTECTION

The equipment must be located in an area where it will remain serviceable, dry and will not be exposed to rain, snow or ground water.

### REMOTE EQUIPMENT PLACEMENT

The pump(s) and control with heater must be installed below water level to ensure priming and maximize performance.

- The equipment should be located as close to the hot tub as possible to maximize jet performance.
- Where you have ordered your hot tub with optional remote equipment, ensure that the equipment is not located more than 3 m. (10 ft.) from the hot tub.
- Use only equivalent size flex-pipe for the pipe runs from the equipment to the hot tub, with minimal use of elbows or other pipe restrictions.
- Install protective waterproof conduit to house applicable cords or line extensions such as the sensor and top-side control cables, light wires or ozone tubing.
- In climates where freeze / thaw occurs we recommend that remote plumbing lines be buried below the frost line and that pipe insulation is applied over all pipes that run from the hot tub to the remote equipment to help maintain energy efficiency.

## UNLOADING / HANDLING YOUR HOT TUB

All HydroPool hot tubs are shipped with a protective combination layer of foam wrap, cardboard and plastic film. Each hot tub is factory strapped onto a wood skid. If your hot tub is to be delivered by your local dealer, it will generally arrive on a flat bed truck or low profile trailer. Most dealers are equipped with the necessary equipment to maneuver the hot tub from the truck to the dolly or cart that will be used to move your hot tub to the installation location.

Should your hot tub arrive in a common closed box trailer, it may be necessary to arrange with a local towing company for a tilt and load tow truck, with a pulley winch system, to pull the skid from the larger trailer to the lower profile tow truck flat bed. The hot tub can be gently slid off the low profile trailer and positioned on its side on a cart or dolly on its back side only.

Most HydroPool models require a clearance width of at least 100 cm. (39 in.) to allow movement of the unit on its side through alley-ways, fence openings, etc. Where this is not possible, the use of a crane to lift the hot tub from the truck or trailer over the house to the patio or yard is often a simple and economical option.



### WARNING

- Do not move or place the hot tub on the side where the equipment is located as damage could occur
- Never roll or flip the hot tub end over end as the cabinet could be damaged
- Never lift or handle the hot tub by the plumbing
- Make sure that there is sufficient assistance to gently slide the hot tub off the dolly or cart to the support base without any damage

**Important Note:** Damage caused during transportation or by improper handling is not covered by the factory warranty.

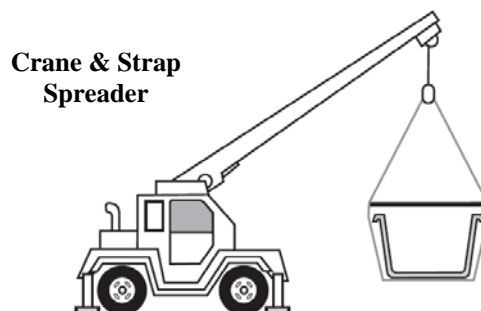
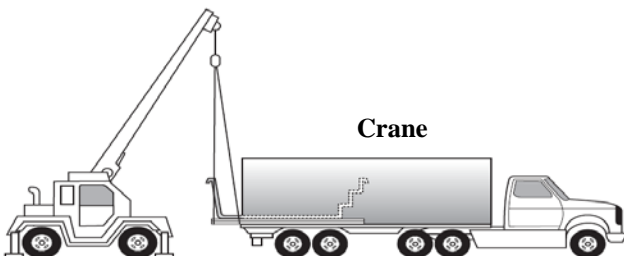

## IMPORTANT ELECTRICAL SAFETY INSTRUCTIONS

**SAFETY COMES FIRST. WHEN INSTALLING & USING THIS ELECTRICAL EQUIPMENT, BASIC SAFETY PRECAUTIONS MUST ALWAYS BE FOLLOWED!**

### 1 READ AND FOLLOW ALL INSTRUCTIONS

2 Electrical installation must be completed by a qualified electrician in accordance with all National, Regional and Local Codes and Regulations in effect at the time of installation.

3 Connect only to a dedicated circuit protected by a class 'A' two-pole ground fault circuit interrupter (GFCI)

### 4 Use copper conductors only!

5 The hot tub equipment and all electrical plugs, outlets and lights within 1.5m (5ft) of the unit must be G.F.C.I protected. Consult your electrician or local electrical authority for further details.

6 A green colored terminal or a terminal marked "G", "GR", "Ground", or "Grounding" is located inside the supply terminal box or compartment. To reduce the risk of electric shock, this terminal must be connected to the grounding means provided in the electric supply service panel with a continuous copper wire equivalent in size to the circuit conductors supplying the equipment.

7 At least two lugs marked "**BONDING LUGS**" are provided on the external surface or on the inside of the supply terminal box or compartment. To reduce the risk of electric shock, connect the local common bonding grid in the area of the hot tub to these terminals with an insulated or bare copper conductor not smaller than No.6 AWG (Canada/Europe) / No.8 AWG (USA).

8 All field installed metal components such as rails, ladders, drains or other similar hardware within 3 m (10 ft) of the hot tub shall be bonded to the equipment grounding bus with copper conductors not smaller than No.6 AWG.

### IMPORTANT NOTE:

- This guide is for standard installations where the wire run is 15 m (50 ft.) or less. For longer wire runs, consult a qualified electrician.

### G.F.C.I./R.C.D. APPLICATION GUIDE FOR HYDROPOOL SELF CLEAN SERIES

#### NORTH AMERICA

Gold Series	40A
Platinum Series	50A
Luxury 60 Jet and Luxury 80 Jet Series	60A

#### EUROPE

Gold Series/Platinum Series	20A
Luxury 60 Jet and Luxury 80 Jet Series	40A

## WIRE SIZE

### NORTH AMERICA

- The minimum wire size for systems that require a 40A GFCI is # 8/3 c/w ground (also referred to as # 8 gauge / 4 conductor).
- The minimum wire size for systems that require a 50A GFCI is # 8/3 c/w ground (also referred to as # 8 gauge / 4 conductor).
- The minimum wire size for systems that require a 60A GFCI is # 6/3 c/w ground (also referred to as # 6 gauge / 4 conductor).

### EUROPE

Standards for amperage breakers may vary from country to country in the CE controlled area. Please consult your local installer for advice on breaker level and wire specifications. Some examples are below:

Breaker of 13A –wire must be 1.5 mm<sup>2</sup>

Breaker of 16A—wire must be 2.5 mm<sup>2</sup>

Breaker of 20A—wire must be 4.0 mm<sup>2</sup>

Breaker of 32A—wire must be 6.0 mm<sup>2</sup>

**NOTE: Please consult your applicable electrical codes related to the size of conductors as they may vary from what is stated above. Take into consideration the length of cable as well and increase as required.**

## NORTH AMERICA – GFCI INSTALLATION



### NOTICE

Installation of the GFCI - Circuit Breaker, including ampere sizing and selection of conductor size and type, must be performed by a qualified electrician in accordance with the National Electrical Code, or the Canadian Electrical Code, and all Federal, State/Provincial and local codes and regulations in effect at the time of installation. HydroPool highly recommends the use of a new Siemens GFCI breaker for all of its products. Other GFCI's and older Siemen's GFCI's may have tripping issues.

### 240 VOLT GFCI WIRING

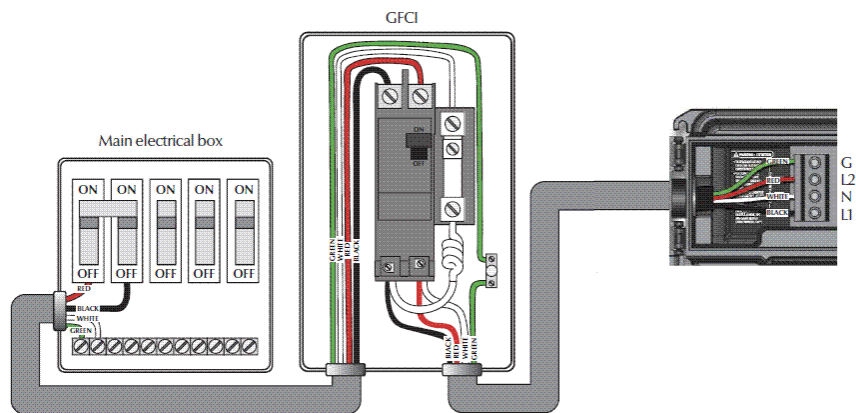

EUROPE – R.C.D. INSTALLATION - TYPICAL



**NOTICE**

Important Note: Installation of the R.C.D. - Circuit Breaker, including ampere sizing and selection of conductor size and type, must be performed by a qualified electrician in accordance with National, Regional and Local Codes and Regulations in effect at the time of installation.

**230 VOLT SINGLE PHASE RCD WIRING**

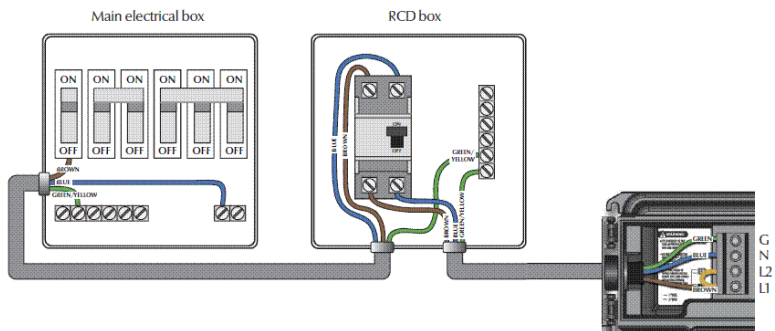

**230 VOLT DUAL PHASE RCD WIRING**

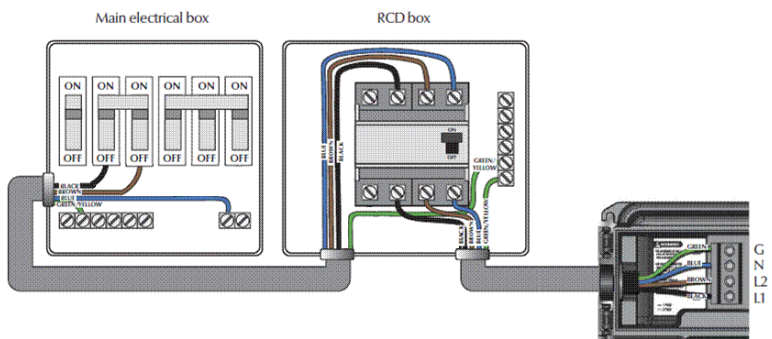

**230 VOLT THREE PHASE RCD WIRING  
(IN.XM PACK ONLY)**

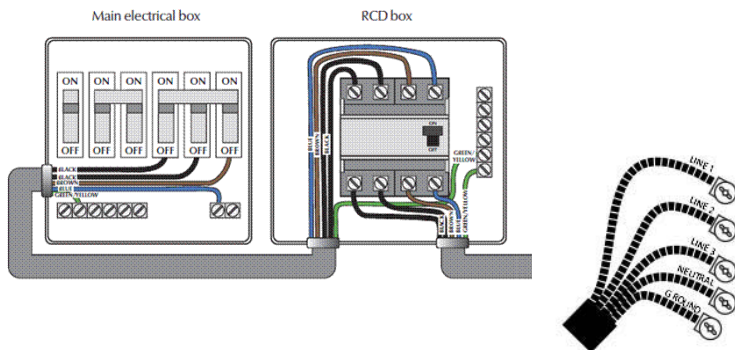

## ACCESSORIES

### OPTIONAL WATERFALL PILLOWS

The adjustable “Waterfall Jet” helps release the body’s natural endorphins that act as a natural pain suppressor and help to relieve stress, headaches and pain. Simply activate the hydrotherapy pump from the electronic keypad and adjust the on/off control to adjust the water flow to your liking.

**NOTE: When not in use, remove the pillows from the hot tub to extend the life of the pillow.**

### OPTIONAL DREAM SCENTS AROMATHERAPY SYSTEM

Operational Instructions:

This exclusive aromatherapy system is independent from the Hydroflex Air Therapy System and uses liquid scents.

**To operate the system is very simple:**

- 1) To fill begin by opening the cap “counterclockwise” on the unit and remove. There are arrows on the cap to indicate the direction in which to turn the cap to open. Then fill the reservoir with your favorite Dreamscent’s liquid scent (or equivalent). To replace cap perform the reverse of the above directions.
- 2) Now the system is ready to work: just push the button to release the scent into the hot tub and repeat to add more liquid scent as desired, please note by turning the button clockwise you can lock it so that any accidental pushing of the button will not result in adding unwanted liquid scent when not desired. To unlock turn button counter-clockwise.



### FILTER/ICE-BUCKET LIDS

The filter and ice-bucket covers provide that finishing touch to your Hydropool hot tub. As the covers are identical to each other, simply place over either opening for a finished appearance.



### SAFETY HARDCOVER LOCKS

Hydropool hard covers are engineered for maximum thermal efficiency and appearance. Simply place the cover on the hot tub, pull the straps down so that they are fully extended, then release slightly so that there is approximately 6 mm (1/4 in.) of slack. Mark the position on the cabinet, and fasten the receiver clip with the screws provided.

### OPTIONAL COVER REMOVER

Hydropool offers several different devices to assist in the removal of the safety hard cover. Please refer to the instructions supplied with your particular cover remover for installation. For further information, contact your local Hydropool retailer.

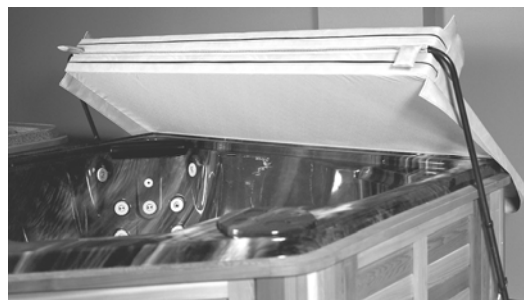

## CAUTION



**Always ensure the safety hard cover is in place and locked whenever the hot tub is not being used. Failure to do so may cause damage or cracking to the acrylic surface not covered under the warranty.**



### OPTIONAL OZONE

All Hydropool hot tubs are factory prepared to accommodate ozonators.

**OPTIONAL STEPS**

HydroPool's optional two-tier step makes entering and exiting your hot tub safe and easy. These steps are available in Clear Cedar, or in various Everlast finishes.



**OPTIONAL ROWING KIT (1038 only)**

The Aquatic Rowing Kit is a combination of stainless steel oars and resistant tether cords that attach to a swivel anchors allowing a full rowing motion.



**OPTIONAL I-COMMAND SYSTEM**

The Smart Phone App that is designed as a wireless hot tub control which allows you to pick the water care settings that fit your schedule. Adjust filtration and temperature settings and create the ideal hot tub experience from inside your home. This option is supported by your iPhone®, iPod touch® and iPad®. Android Smartphones will be available mid summer 2014. Please contact your local retailer for more information.

If your hot tub comes with this option installed, you need to activate the App Store Icon from your IPOD menu. Type in **“in.touch Gecko”** into the search field to find the application (**Gecko Home or World Editions**) and download from iTunes using your user name and password.

The in.touch world edition allows you to use the Internet anywhere in the world to control your spa.

The in.touch home edition allows you to control your spa using your home WiFi network.

1. Go to the Wi-Fi Networks screen by touching the Settings Icon. The network named in.touch should appear on the list.
2. Press on it to select the in.touch network. Once you've selected it, wait until the WiFi icon appears on the top left corner of the screen. This icon shows that your iDevice is now connected to the network.
3. You can now start the application by finding the icon for the in.touch application and tapping to open it.
4. The first time you use the app a message will tell you to add a spa to your list. You must add your hot tub to the list in order to configure it and use it with the application. Once you tap Ok, you will see a list of visible hot tubs. Tap on yours. Name it when prompted. (NOTE: Both your hot tub and your iDevice must be in range of your home WiFi System to ensure proper operation).
5. Go to Settings in the in.touch app and select WiFi Connection. Choose the network you want your spa to connect to (i.e. your home WiFi). If the network has a security key, enter it when prompted.
6. Home Network - Go to the WiFi settings section on your device and choose the same network.
7. Internet (World Edition only) - Once your spa is connected to the internet, you can use your in.touch world edition any time your device is also connected to the internet, even if you are away from home. The green icon with the word "Linked" beside it will appear at the top righthand corner of the My Spas page to confirm your connection.



## FILLING, CHECKING AND STARTING YOUR HOT TUB

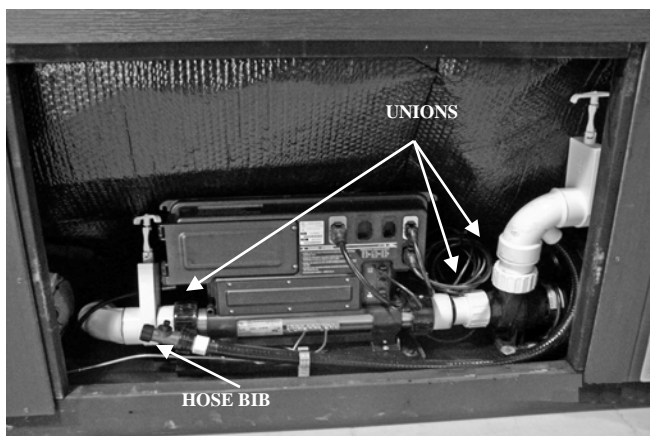

**PROPER WATER LEVEL**

### FILLING

When adding water for the first time, the hot tub should be filled through the skimmer opening (helps to prevent air locks) using a standard garden hose, turning the tap on slowly to prevent damage to the surface by a jerking hose connection.

- Pull up the handles on the intake and return gate valves and clip on the stem locks. (handles are pulled up when valves are open and pushed down when valves are closed).
- Ensure the drain hose-bib is closed.
- Ensure that all jets are open.

### See section JET & FEATURE OPERATION

- Fill the hot tub to the recommended level as indicated by the "MIN" and "MAX" marks on the weir door of the skimmer opening.

### CHECKING

Although your hot tub was thoroughly water-tested in the factory, some loosening of fittings can occur during shipping. Before any decking, tiling or carpeting is completed around the installation, fill and operate your hot tub to test for leaks (this ensures easy access and inexpensive correction). Check all union connections and plumbing for minor leaks. In the event of a leak, ensure all union connections and pump plugs are tight and all o-rings/gaskets are in place.

### STARTING

Before applying voltage to power-up your hot tub, it is very important that you understand the sequence of events that occur when the system is activated in order that the pump can be primed efficiently and damage to the system can be avoided.

- Turn the main power "on" at your electrical panel.
- Follow the control instructions for your particular model hot tub to put the pump into low speed.

### See section HYDROPOOL CONTROL SYSTEMS

### PUMP PRIMING/RELEASING AN AIR LOCK

On some systems a message will appear on the display indicating that the system is in **PUMP PRIMING MODE**.

This mode will last for 4 to 5 minutes before automatically entering the normal operation mode. **See complete details for your spa in section HYDROPOOL CONTROL SYSTEMS**

When the hot tub pump is located below water level, the water should start circulating immediately. If the motor works but if you do not notice water circulation within the first 15 seconds, the pump may require priming due to trapped air (referred to as an 'air lock'). To prime (inset 2), open the hose-bib to allow trapped air to escape. Close as soon as the water flow from the jets becomes regular. If the pumps have not primed after 2 minutes, and water is not flowing from the jets, **DO NOT** allow the pumps to continue to run. Turn power off at the main house panel (or GFCI) and try releasing the air again by loosening the union on the discharge side of the pump(s) while the motor is not running. Turn the power back on. If the pump(s) does not prime after 15 seconds, sometimes momentarily turning the pump(s) off and on will help the system to prime (note: do not do this more than 5 times). Repeat if necessary.

- **Important:** Under NO circumstances should the pump(s) be allowed to operate without priming beyond 5 minutes, as this may not only cause unwarrantable damage to the pump, it may also cause the control system to go into an overheat condition.

**Definition:** 'Priming' a pump is a term used to describe the process in which air trapped in the plumbing and pump wetend (referred to as an 'air lock') is released, allowing the pump to move water efficiently through the plumbing system and to the jets.

## RELEASING AIR TRAPPED IN FILTER...

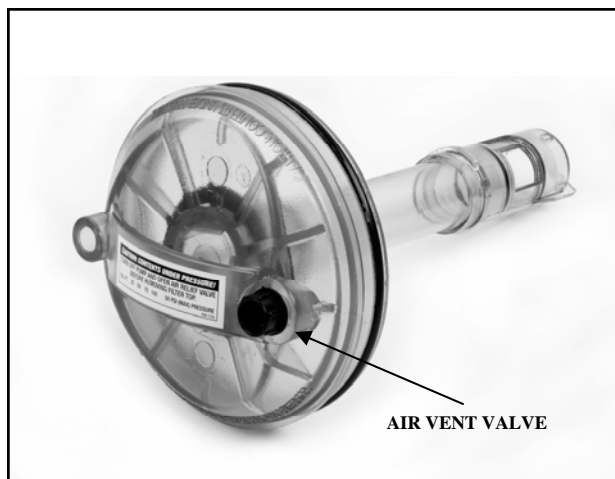

- When the pump starts circulating, it will be necessary to release trapped air in the filter. Carefully loosen the air vent valve counter-clockwise until there is the hissing sound of air escaping. Once there is a steady stream of water, close the vent valve, ensuring that the o-ring does not become pinched.

- Turn the Hydrotherapy pump(s) on and re-check for leaks. The control system will automatically return the pump(s) off after 15 minutes.

- Adjust the hot tub heat control at the topside panel to the desired water temperature.

- Adjust water balance (pH, TA, calcium hardness) to recommended levels and add sanitizer once the water temperature reaches 20°C (68°F).

### See section HOT TUB WATER BALANCE

- Keep insulated safety hard cover on the hot tub, and the air controls closed during the entire heat up process.



## HYDROPOOL SELF CLEAN SERIES CONTROL SYSTEMS

### NORTH AMERICA / EUROPE

#### GECKO IN.XE & IN.XM SPA PACK SERIES



#### INITIAL START-UP

Before applying voltage to power-up your hot tub, it is very important that you understand the sequence of events that occur when the system is activated in order that the pump can be primed efficiently and damage to the system can be avoided.

At initial power-up, the system will do a lamp test where all of the segments and LED's are lighting up. Then the system will show the software part number, the software revision and then the low level selection.

After the initial software indicators are shown, the display will flash between temperature (--- °F) and time (12:00 pm).

This display is indicating that the system is in **PUMP PRIMING MODE**. In this mode pump 2 (if installed) will run for one minute and then it will turn off and the system will activate pump 1 to run for one minute before automatically exiting and entering the normal operation mode.

While in this mode, the heater circuit is disabled to allow the priming process to be completed without the possibility of energizing the heater element during low flow or no flow conditions. The system will not automatically activate any of the functions, however, by pushing the pad on the topside control, the pump can be manually activated to facilitate priming.

**Definition:** 'Priming' a pump is a term used to describe the process in which air trapped in the plumbing and pump wet-end (referred to as an 'air lock') is released, allowing the pump to move water efficiently through the plumbing system and to the jets.



#### TEMPERATURE CONTROL FUNCTIONALITY AND ADJUSTMENT

After you manually exit or the system automatically exits Priming Mode, your hot tub will automatically heat to the factory preset default temperature of 38°C (100°F) The topside panel will briefly show the default temperature, and then the display will show (--- °F) and time (12:00 pm).

Note that the water temperature is not yet displayed, as the system requires approximately 2 minutes of water flow through the heater to determine temperature. After 2 minutes the display will show the current measured water temperature

Press the keypad to increase the temperature to the desired setting. The heat indicator light on the topside panel will turn on indicating that the display shows the desired temperature, NOT the current water temperature.

#### **To Check/Change the Set Temperature**

The last measured temperature is constantly displayed on the topside panel. When this pad is pressed once any time during normal operation, the display will show the set temperature for 5 seconds. Press this pad a second time to increase or decrease the set temperature. To change the direction of the temperature settings (ie. lower vs. raise the temperature), allow the display to revert back to the current water temperature then press the pad again.

The temperature can be adjusted from 15°C (59°F) to 40°C (104°F) in 0.5°C (1°F) increments.

#### **Heater Function**

In a regulation cycle, the system first generates water flow through the heater housing and the plumbing, in order to ensure accurate water temperature readings as well as avoiding heater activation in dry conditions.

The system verifies periodically that all parameters are within the normal range.

If the readings received from the system are not valid, blanks (---) will be displayed until normal readings have been successfully found.

After verifying pump activation and taking a water temperature reading if required, the system automatically turns the heater on to reach and maintain water temperature at the set point. The heater indicator lights up when the heater is on, It flashes when there is a request for more heat but the heater has not started yet.

HYDROPOOL SELF CLEAN SERIES CONTROL SYSTEMS  
NORTH AMERICA / EUROPE  
GECKO IN.XE3 GOLD CONTROLS



KEYPAD FUNCTIONS AND DISPLAY ICONS



JET 1 KEY WHICH CONTROLS PUMP 1



ECON KEY WHICH SETS THE ECONOMY MODE



ILLUM KEY WHICH CONTROLS THE LIGHTING



FILTER KEY WHICH SETS THE FILTER CYCLES



TEMP + KEY WHICH CONTROLS THE TEMPERATURE AND SCROLLS THROUGH THE MENU



TEMP - KEY WHICH CONTROLS THE TEMPERATURE AND SCROLLS THROUGH THE MENU



OTHER DISPLAY ICONS



CLOCK ICON SHOWS UP ON THE DISPLAY WHEN PROGRAMMING THE TIME OF DAY AND FILTER CYCLE SETTINGS.



TEMPERATURE ICON SHOWS UP ON THE DISPLAY WHEN YOU PRESS EITHER TEMPERATURE KEY INDICATING THAT YOU ARE ADJUSTING THE TEMPERATURE.

HYDROPOOL SELF CLEAN SERIES CONTROL SYSTEMS  
NORTH AMERICA / EUROPE  
GECKO IN.XE5 PLATINUM AND LUXURY CONTROLS



KEYPAD FUNCTIONS AND DISPLAY ICONS



JET 1 KEY WHICH CONTROLS PUMP 1



ECON KEY WHICH SETS THE ECONOMY MODE



JET 2 KEY WHICH CONTROLS PUMP 2



FILTER KEY WHICH SETS THE FILTER CYCLES



ILLUM KEY WHICH CONTROLS THE LIGHTING



TEMP + KEY WHICH CONTROLS THE TEMPERATURE AND SCROLLS THROUGH THE MENUS



TEMP - KEY WHICH CONTROLS THE TEMPERATURE AND SCROLLS THROUGH THE MENUS



OTHER DISPLAY ICONS



CLOCK ICON SHOWS UP ON THE DISPLAY WHEN PROGRAMMING THE TIME OF DAY AND FILTER CYCLE SETTINGS.



TEMPERATURE ICON SHOWS UP ON THE DISPLAY WHEN YOU PRESS EITHER TEMPERATURE KEY INDICATING THAT YOU ARE ADJUSTING THE TEMPERATURE.



## PUMP 1 FUNCTION

Press the **JET1** keypad to activate Pump 1

- 1st press** – turns the pump on low speed
- 2nd press**—turns the pump on high speed
- 3rd press** – turns the pump off



## PUMP 2 FUNCTION (if equipped)

Press the **JET2** keypad to activate Pump 2

- 1st press** – turns the pump on high speed
- 2nd press**—turns the pump off

### PUMP AUTOMATIC TIME-OUTS

**High speed** – 15 minutes

**Low speed** – 30 minutes



## SETTING THE TIME OF DAY

In order to set the time of day you must press and hold the **FILTER** key for 5 seconds. The display will show the time of day with the hours flashing. Use the temperature keys to change the hours. A press of the **FILTER** key will then flash the minutes. Once again use the temperature keys to change the minutes. A final press of the **FILTER** key will program the time and continue on to program the filter cycle and economy mode operations.



## FILTER CYCLES

To program the filter cycles, you must enter the duration of the cycle and frequency of the cycle. During a filter cycle the pumps run for one minute to purge the plumbing and then the filtration pump runs for the remaining duration of the filter cycle.

## PROGRAMMING THE FILTER CYCLE

After you have successfully set the time of day, you will continue on to program the filter cycle. You must press and hold the **FILTER** key for 5 seconds. The display will show the time of day with the hours flashing. A press of the **FILTER** key will then flash the minutes. A press of the **FILTER** key will display **FS (filter start time)**. Use the temperature **UP** and **DN** keys to select the start time. A press of the **FILTER** key will display **FD (filter duration)**. Use the temperature **UP** and **DN** keys to select the duration (0-24 hrs). A press of the **FILTER** key will display **FF (filter frequency)**. Use the temperature **UP** and **DN** keys to set the frequency (1-2). A final press of the **FILTER** key will program the filter cycles and continue on to program the economy mode operation.



## ECONOMY MODE

Economy Mode allows you to set the water temperature back 20°F (10°C)

during the programmed times of the day for automatic operation or for as long as the system is set by using the Keypad for manual operation. To set the automatic operation you must enable the automatic programming, you must enter the start time, and you must enter the duration of the cycle. To set manual operation you simply need to press the **ECON** key on the keypad. In manual mode the display will show “**Eco**” when you turn the mode on and “**noE**” when you turn it off.



## PROGRAMMING THE ECONOMY MODE

After you have successfully set the time of day and filter cycles, you will continue on to program the economy mode. A press of the **FILTER** key will display **EP (economy mode programming)**. Use the temperature **UP** and **DN** keys to turn off or on (0-1). A press of the **FILTER** key will display **ES (economy start)**. Use the temperature **UP** and **DN** keys to set the start time. A press of the **FILTER** key will display **ED (economy duration)**. A press of the temperature **UP** and **DN** keys will select the duration (1-24 hrs). A press of the **FILTER** key will display a flashing F. Use the temperature **UP** and **DN** keys to toggle between **F** and **C**. Press the **FILTER** key to exit the programming.

## STANDBY / DRAIN ASSIST MODE



A press of the **JET 1** key for 5 seconds will enable the “**STANDBY MODE**” and will display “**OFF**”. This mode allows you to stop all outputs including all automatic functions such as a filter cycle, heating requests and smart winter mode purging for 30 minutes to perform quick spa maintenance. When the “**STANDBY MODE**” is activated, the display will toggle between the “**OFF**” message, the water temperature and the time.

Press the “**JET 1**” key twice or the “**JET 2**” key once to restart the system before the expiration of the 30 minute delay.. The spa light will flash a few seconds before the end of the 30 minutes to warn you the system is about to resume its normal operation and the display will then show “**ON**” for 3 seconds.

Once the “**OFF**” mode is enabled, a quick press of the “**JET 1**” key will activate the “**DRAIN MODE**” and will display “**drn**”. The filtration pump will turn on and run for 60 minutes. If your tub has not been completely drained down you can simply press the “**JET 1**” key again to continue the cycle. A press of any key will disable the “**OFF**” and “**DRAIN**” mode and resume its normal operation.



### **SMART WINTER MODE**

Smart Winter Mode protects your system from the cold by turning the pumps on several times a day to prevent water from freezing in the pipes.

The Smart Winter Mode indicator turns on when in this mode of operation.

If the temperature drops to 4°C (39°F) within the heater chamber, the system automatically activates the pump to provide freeze protection. The pump will operate until the temperature reaches 5°C (41°F) before returning to normal system mode.

### **COOL DOWN**

After heating the spa water to the desired set point, the heater is turned off, but the filtration pump remains on for a certain amount of time to ensure adequate cooling of the heating element in order to prolong the useful life of the heater. The heater icon flashes during this time.

### **PURGE CYCLES**

The purge cycles are programmed to begin at the start of each filter cycle. Pump 2 activates for 1 minute, shuts off and then Pump 1 activates for 1 minute and then shuts off.

### **OPTIONAL OZONATOR**

The ozonator operates during **FILTER CYCLES** only and remains off for 30 minutes after usage.

HYDROPOOL SELF CLEAN SERIES CONTROL SYSTEMS  
NORTH AMERICA / EUROPE  
GECKO IN.XM LUXURY CONTROLS AND OPTIONAL HYDROTHER OPERATION



KEYPAD FUNCTIONS AND DISPLAY ICONS



FUNCTION KEY WHICH OPERATES THE DEVICE OR SELECTS THE MODE REPRESENTED BY THE DISPLAY ICON TO THE LEFT OF THE KEY



MODE KEY WHICH DISPLAYS THE OPERATING MODES (SPA, THERAPY AND OPTIONS)



NEXT PAGE KEY WHICH ALLOWS THE USER TO GO TO THE NEXT PAGE IN ANY MENU SYSTEM



NAVIGATION KEYS

PRESS THE "OK" TO TOGGLE BETWEEN THE TIME AND WATER TEMPERATURE.

PRESS THE "INCREASE/ DECREASE" (+/-) KEYS TO RAISE OR LOWER VALUES IN THE MENU

PRESS THE "FORWARD/ BACKWARD" (</>) KEYS TO MOVE BETWEEN SELECTIONS

OTHER DISPLAY ICONS



LIGHT ICON INDICATING THAT THE SPA LIGHTING FEATURES ARE RUNNING.



PUMP 1 ICON INDICATING THE PUMP IS RUNNING ON LOW/ HIGH SPEED OR OFF



PUMP 2 ICON INDICATING THE PUMP IS RUNNING ON HIGH SPEED OR OFF.



PUMP 3 ICON INDICATING THE PUMP IS RUNNING ON HIGH SPEED OR OFF.



BLOWER ICON INDICATING THAT THE REMOTE KEYPAD CONTROL IS ONE



ECONOMY MODE ICON INDICATING THAT THE FEATURE IS ON/OFF.



STANDBY MODE ICON INDICATING THAT THE SPA OPERATION IS ON/OFF.



SMART WINTER MODE ICON INDICATING THAT THE COLD PROTECTION IS RUNNING



FILTER ICON INDICATING THAT THE SPA IS IN A FILTER CYCLE.



HEAT ICON INDICATING THAT THE SPA WATER IS BEING HEATED.



SERVICE ICON INDICATING THAT THERE IS AN ISSUE THAT NEEDS YOUR ATTENTION



### PUMP 1 FUNCTION



Press the **FUNCTION** keypad next to Pump 1 to activate its operation as indicated below.

- 1st press – turns the pump on low speed
- 2nd press—turns the pump on high speed
- 3rd press – turns the pump off



### PUMP 3 FUNCTION (if installed)



Press the **FUNCTION** keypad next to Pump 3 to activate its operation as indicated below.

- 1st press – turns the pump on high speed
- 2nd press—turns the pump off



### PUMP 2 FUNCTION



Press the **FUNCTION** keypad next to Pump 2 to activate its operation as indicated below.

- 1st press – turns the pump on high speed
- 2nd press—turns the pump off

### PUMP AUTOMATIC TIME-OUTS

- High speed – 15 minutes
- Low speed – 30 minutes

## SETTING THE TIME OF DAY

In order to set the time of day you must press the **MODE** key to bring you back to the main menu. Press the **FUNCTION** key beside **OPTIONS** to select this submenu. Press the **FUNCTION** key beside **CLOCK** to select this submenu. Press the **+/-** keys to set the hours. Press the **>** key to access the minutes. Press **+/-** to set the minutes and then press the **FUNCTION** key to save the settings. Press the **MODE** key to exit out to the main menu and then press the **FUNCTION** key to enter back into **SPA MODE**

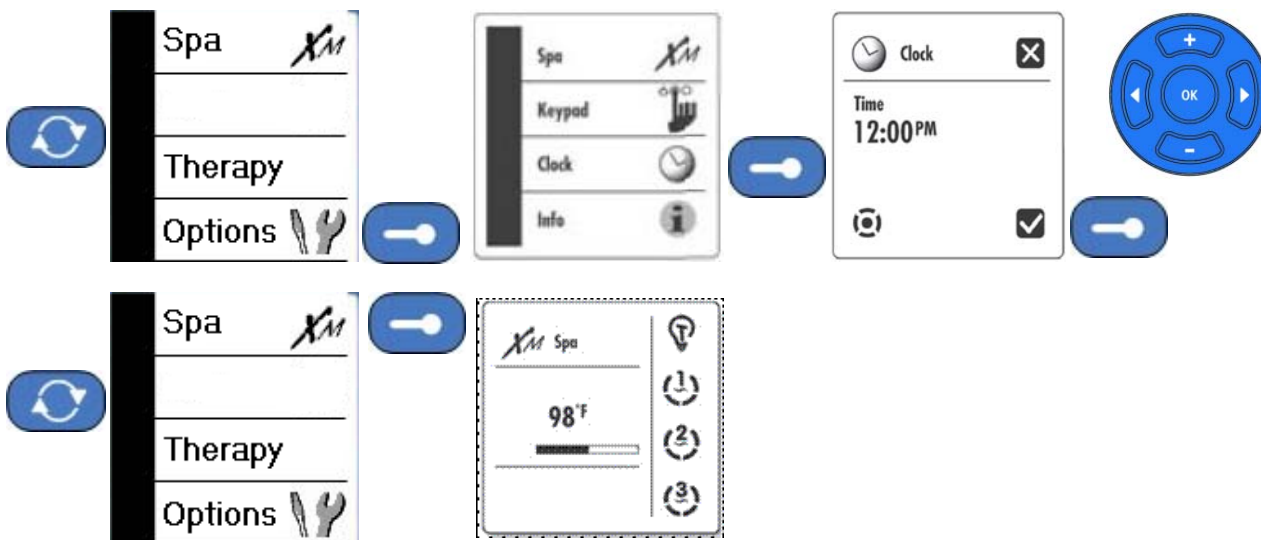

## FILTER CYCLES

To program the filter cycles, you must enter the duration of the cycle and frequency of the cycle. During a filter cycle the pumps run for one minute to purge the plumbing and then the filtration pump runs for the remaining duration of the filter cycle. We recommend you start with as long a filter cycle as possible (**factory default is set to 24 hours**) and over time, if you wish, you can reduce your filter cycles depending on your usage, chemical program and overall water quality.

### PROGRAMMING THE FILTER CYCLE

In order to set the filter cycles you must press the **MODE** key to bring you back to the main menu. Press the **FUNCTION** key beside **OPTIONS** to select this submenu. Press the **FUNCTION** key beside **SPA** to select this submenu. Press the **FUNCTION** key beside **FILTER** to select this submenu. Press the **+/-** keys to set the start hours. Press the **>** key to access the minutes. Press the **FUNCTION** key on the bottom to go to the duration submenu. Press **+/-** to set the duration time. Press the **FUNCTION** key on the bottom to go to the frequency submenu. Press the **+/-** to set the frequency. Press the **FUNCTION** key to save the settings. Press the **MODE** key to exit out to the main menu and then press the **FUNCTION** key to enter back into **SPA MODE**

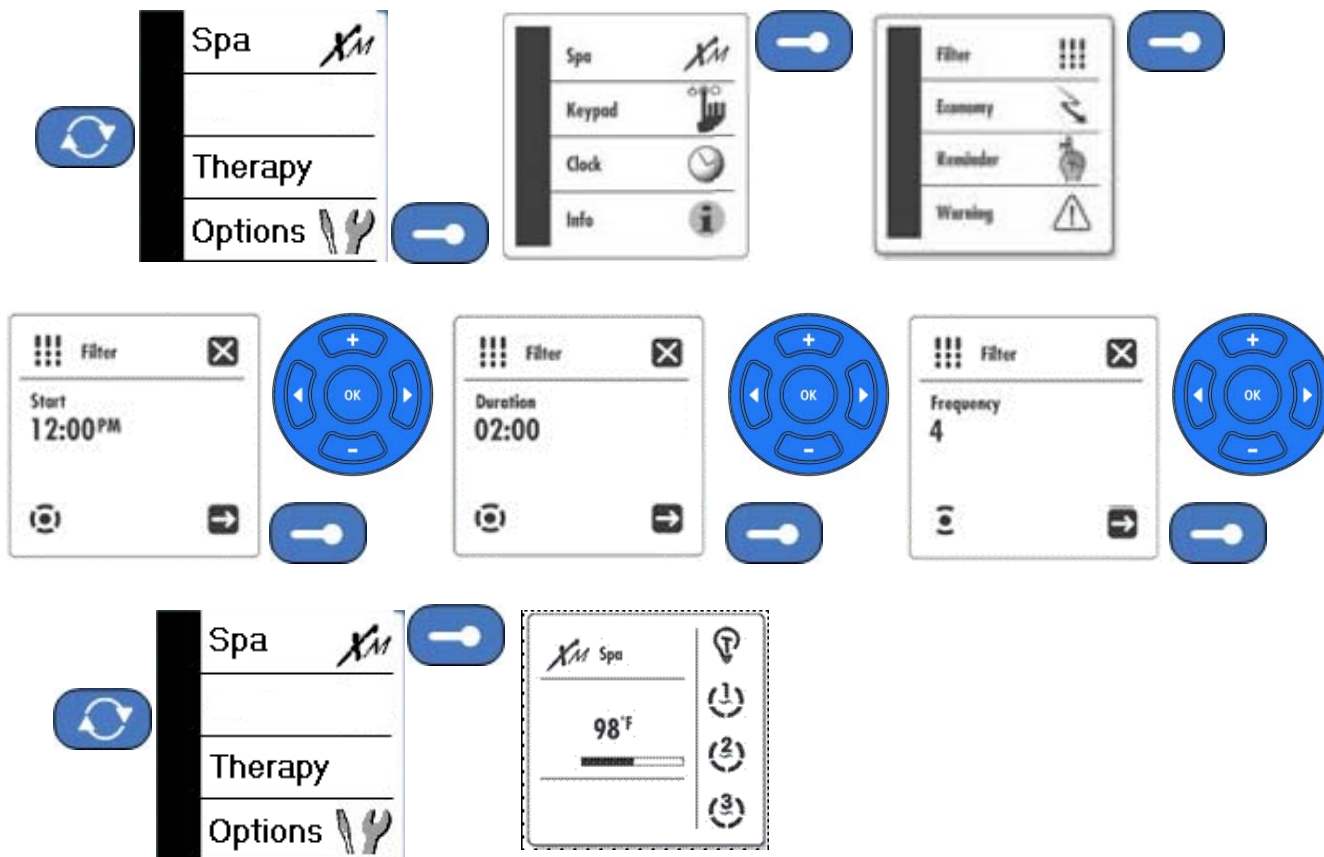



## ECONOMY MODE

Economy Mode allows you to set the water temperature back 20°F (10°C) during the programmed times of the day for automatic operation. To set the automatic operation you must enable the automatic programming, you must enter the start time, and you must enter the duration of the cycle.

## PROGRAMMING THE ECONOMY MODE

In order to set the economy mode you must press the **MODE** key to bring you back to the main menu. Press the **FUNCTION** key beside **OPTIONS** to select this submenu. Press the **FUNCTION** key beside **SPA** to select this submenu. Press the **FUNCTION** key beside **ECONOMY** to select this submenu. Press the +/- keys to set the start hours. Press the > key to access the minutes. Press the **FUNCTION** key on the bottom to go to the stop time submenu. Press +/- to set the stop time. Press the **FUNCTION** key to save the settings. Press the **MODE** key to exit out to the main menu and then press the **FUNCTION** key to enter back into **SPA MODE**

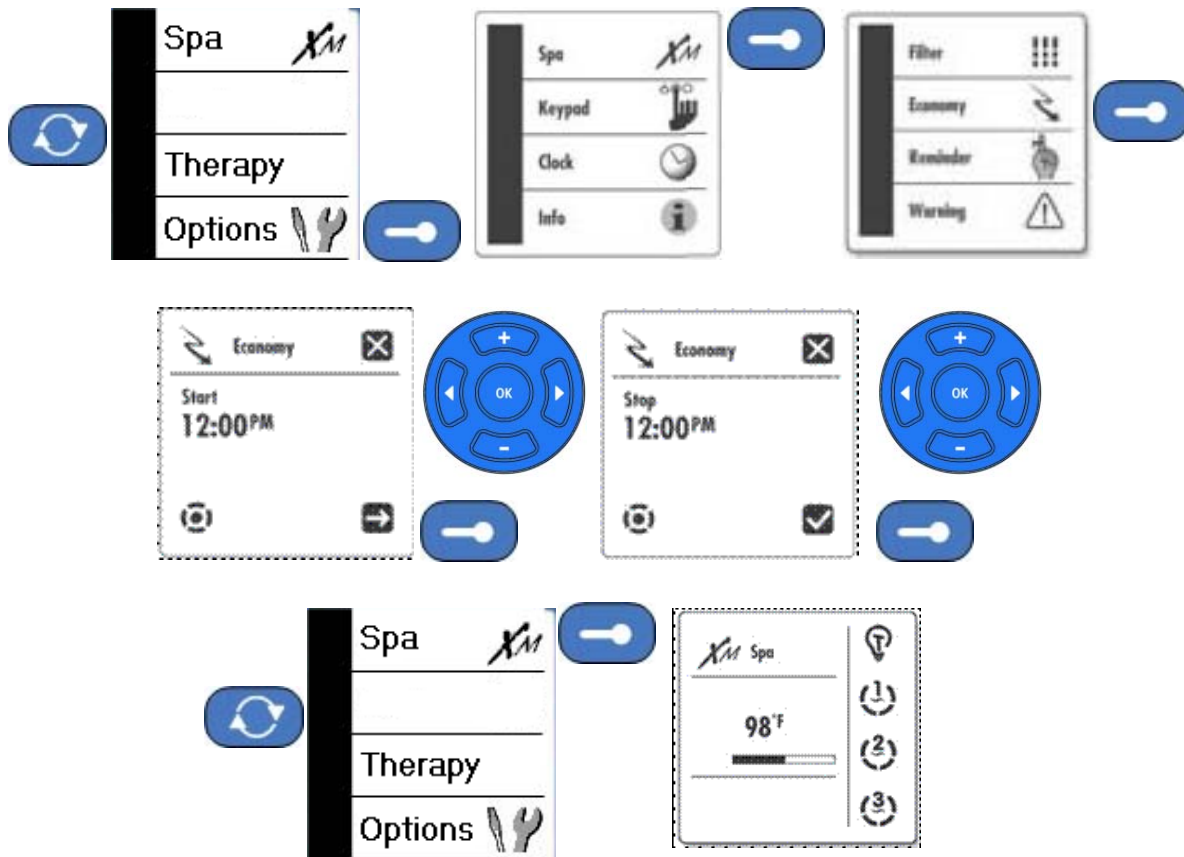

## STANDBY / DRAIN ASSIST MODE

This mode allows you to stop all outputs including all automatic functions such as a filter cycle, heating requests and smart winter mode purging for 30 minutes to perform quick spa maintenance. When the “**STANDBY MODE**” is activated, the display will indicate “**Standby**” and will flash the icons whose operation is stopped. From this point if you chose to, you can then proceed to enable the “**DRAIN MODE**”.

## PROGRAMMING THE STANDBY AND DRAIN ASSIST MODE

In order to enable the **STANDBY** mode you must press the **NEXT** key to bring you to the next page which shows the **ON/OFF** icon. Press the **FUNCTION** key beside **ON/OFF** to select and the unit will now be in **STANDBY MODE**.

From this point if you wish to go into **DRAIN MODE**, follow the next sequence of steps. Press the **NEXT** key to return to the original page with the light and pump icons. Press the **FUNCTION** key beside **PUMP 1** to select the **DRAIN** mode. this submenu. **Ensure the proper gate valves are closed and a garden hose is attached to the drain before doing so.** To exit out of drain mode, press the **FUNCTION** key beside the **X**. This will bring you back to the original page with the light and pump icons. Press the **NEXT** key to go to the next page which shows the **ON/OFF** icon. Press the **FUNCTION** key beside the ON/OFF icon to exit out of the **STANDBY** mode. Press the **NEXT** key to navigate back to **SPA MODE**

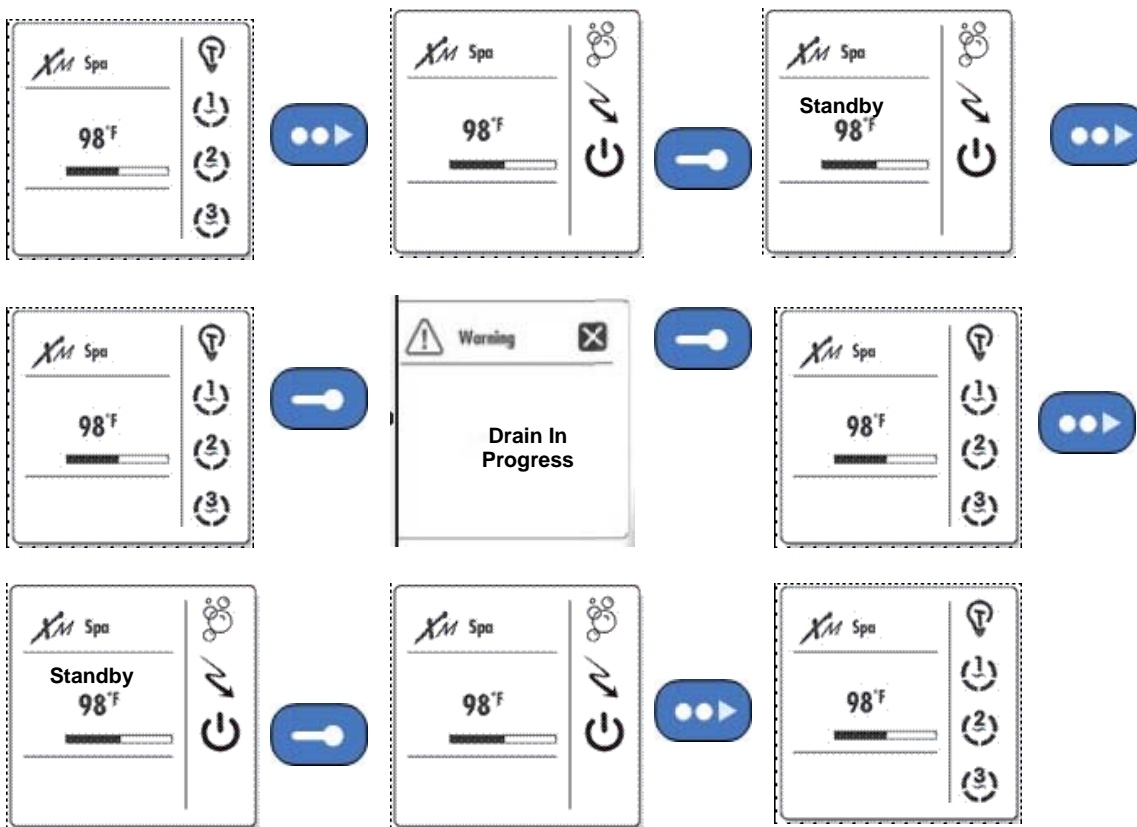

## OPTIONAL HYDROTHER CONTROL AND WELLNESS THERAPY PACKAGE

This optional feature allows you to select from eight different therapy packages to help soothe your aches and pains or focus on key parts of your body that need some attention. In order to select the therapy you are looking for please reference the “Wellness Guide” that came with your hot tub and follow the instructions below.

### PROGRAMMING THE HYDROTHER / WELLNESS THERAPY

From the main display page, press the **MODE** key to navigate into the submenu. Press the **FUNCTION** key beside the **THERAPY** mode. From there you will see the first selection page which offers your four optional therapy packages (**LEG, BACK, DIET+, SPORT+**). If you wish to select one of these packages simply press the **FUNCTION** key beside the therapy you are looking for. If not, press the **NEXT** key to go to the second page which offers you another four optional therapy package (**HEADACHE, INSOMNIA, STRESS, TONIC**). Press the **FUNCTION** key beside the therapy you are looking for a relax.

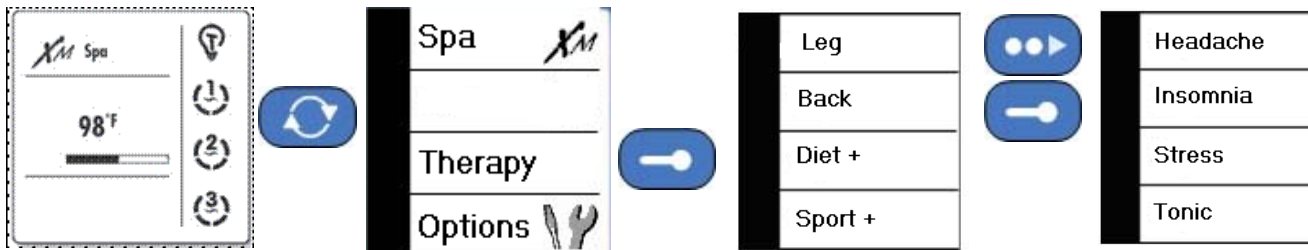

## TOPSIDE PANEL DISPLAY MESSAGES

**Hr** - An internal hardware error has been detected

**Prr** - The Prr error message indicates a problem with the regulation probe. The system is constantly verifying if the temperature probe reading is within its normal limits.

**HL** - The water temperature at the heater has reached 119°F (48°C). **Do not enter spa water.**

**FLO** - The system did not detect any water flow while the filtration pump was running.

**UPL** - No low level configuration software has been downloaded into the system.

**AOH** - The temperature inside the spa skirt is too high, causing the internal temperature in the spa pack to increase above the normal limits.

**OH** - The water temperature in the spa has reached 108°F (42°C). **Do not enter spa water.**

### OPTIONAL VARIABLE AIR THERAPY SYSTEM CONTROL FUNCTIONS:

**Press:** Blower button on main control to activate system.

**1) ON/OFF :**

**Press 1:** The Blower starts at maximum Speed. LED: ON

**Press 2:** The blower stops. LED: OFF

**2) TO CONTROL SPEED:**

**Press 1 and hold:** Speed goes up or down, LED: ON when pressing. Release pressure at the desired speed.

**3) TO CONTROL PULSATION:**

**Press 1:** Slow Pulsation Cycle, LED: ON.

**Press 2:** Quick Pulsation Cycle, LED: Flashes.

**Press 3:** Pulsation Cycle OFF, LED: OFF.



## JET AND FEATURE OPERATION



### JET WATER FLOW ADJUSTMENT

Your HydroPool hot tub features adjustable water flow on specific hydrotherapy jets. To reduce the flow: grasp the outer flange of the jet, and turn clockwise approximately a 1/4 turn. When it hits the stop, the jet is considered closed, and flow will be restricted. To increase the flow: from the closed position, turn the jet counterclockwise approximately 1/4 turn. When it hits the stop, the jet is open, and there is maximum jet flow. Do not attempt to turn the jet past the stop, as this will unclip the jet internal from the socket. **(NOTE: Jets used for acupressure sequence massage are not adjustable whether or not the system is included in your spa).**

### JET AIR FLOW ADJUSTMENT

Your HydroPool hot tub features adjustable airflow on specific hydrotherapy jets. To stop the flow: push the toggle button to the off position. When it hits the stop, the air is closed, and airflow will be restricted. To turn on the flow: push the toggle button to the on position. When it hits the stop, the air control is fully opened. For maximum operating efficiency, the air controls must remain closed when your hot tub is not in use.

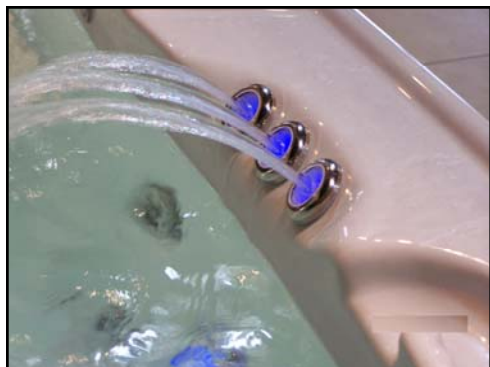

### INTERCHANGING JET INSERTS

A great feature for custom tailoring the jets in your HydroPool hot tub to suit your personal hydrotherapy needs. Jets of like size and dimension may be interchanged with each other, for example, if you wished to swap a Poly Storm Directional jet for a Poly Storm Twin Roto jet, or a Mini Storm Twin Roto jet for a Mini Storm Directional jet.

### CLEANING STAINLESS STEEL JETS:

Use a Cleaner such as Brasso or Stainless Steel Cleaner to bring back the lustre to your Stainless Steel parts after each drain and fill. This must be done otherwise the stainless steel will discolor and possibly rust due to chemical exposure.

### CLEANING OPTIONAL CASCADING WATERFALL JETS

- 1 Put hot tub in Stand By Mode.
- 2 Rotate outer ring of Cascading Jet Counter Clockwise to remove cover.
- 3 Grab center nozzle, pull it out to clean and then rinse.
- 4 Reassemble in reverse order.

### OPTIONAL ACUPRESSURE SEQUENCE MASSAGE FILTER

This filter must be cleaned at each drain and refill of your hot tub to ensure proper functionality of the Acupressure Sequence Massage. It is located behind the door in the equipment area. To access the filter screen turn large canister section of the assembly counter-clockwise till the apparatus separates revealing screen filter. Run filter under tap to clean out any debris and reassemble in reverse order.



## JET INSERT REMOVAL & REPLACEMENT

### POLY/MINI STORM DIRECTIONAL & TWIN ROTO POWER STORM MASSAGE & TWIN ROTO

**TO REMOVE:**

- Turn the jet counter-clockwise to unclip & pull out of socket.

**TO RE-INSTALL:**

- Push the jet into the socket until it snaps into place, ensuring the square pin on the back of the jet lines-up with the groove in the socket flange.



**DIVERTER VALVE**

Your HYDROPOOL hot tub is equipped with a diverter valve. It allows you to direct the flow of the water to different zones in your hot tub.

**ALWAYS:** return the valve handle to the middle position before exiting the hot tub.

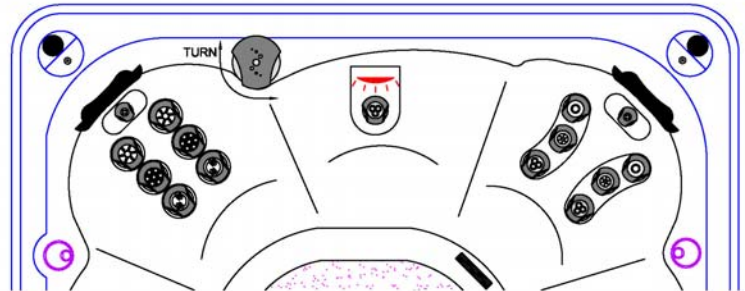

**OPTIONAL WATERFALL CONTROL**

If your hot tub was ordered with the optional waterfall feature, then you will have a waterfall flow control valve. The waterfall feature was designed to provide a gentle cascade of water into the bathing area of the spa. Simply turn the top of the control clockwise for less water flow, and counterclockwise for more water flow.



## OPTIONAL HYDROPOOL SURROUND SOUND AUDIO AND DOCKING STATION

### DOCKING YOUR AUDIO DEVICE

The Docking Station is compatible with all alternate audio sources such as IPOD, USB and MP3 players.

**To install any audio device:**

- 1 Locate and open the Docking Station door by gently pulling upward on the handle.
- 2 Remove the connector cover prior to plugging in your audio source. Always keep the cover on when the docking station is not in use.
- 3 Center the device over the Docking Station Adaptor and connect.
- 4 Close the Docking Station door once you have begun using your device.



Audio source placement in pop out tray (device not included)

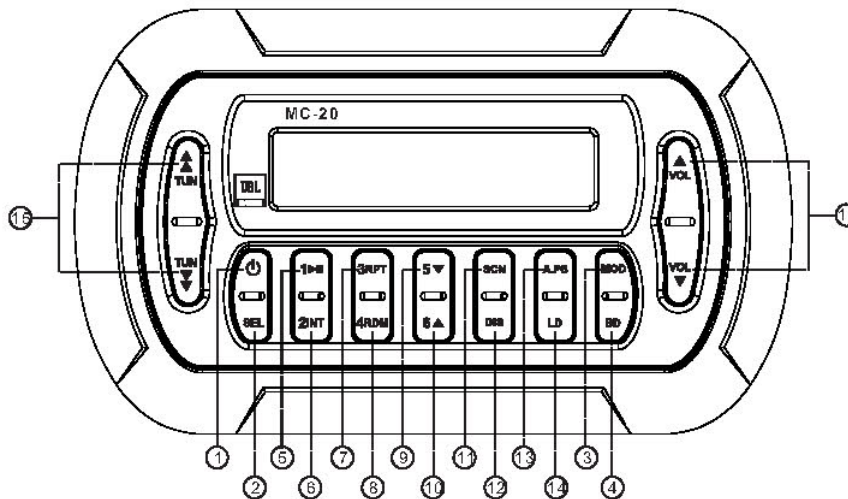

### HYDROPOOL SURROUND SOUND STEREO RECEIVER

1. Power ON / OFF button, MUTE button.
2. SELECT button
3. MODE button (Radio-->USB-->AUX-IN-->BT MUSIC)
4. BAND function
5. Radio preset 1 button, Play/Pause button
6. Radio preset 2 button, Intro button
7. Radio preset 3 button, Repeat Play button
8. Radio preset 4 button, Random Play button
9. Radio preset 5 button, Directory Up button
10. Radio preset 6 button, Directory Down button
11. SCAN button
12. DISP (display) button
13. A.P.S - Auto Preset Scan button
14. LOUD (loudness) button
15. Tune Up/Down button, Track Up/Down button
16. Volume Up/Down button

## OPTIONAL HYDROPOOL SURROUND SOUND AUDIO AND DOCKING STATION (continued)

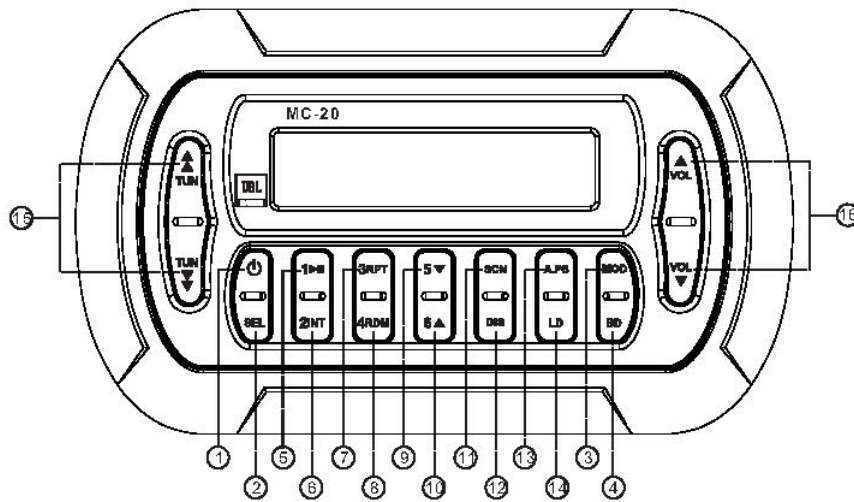

### RADIO OPERATION

#### Radio Operation

Press MOD button (3) to select Radio mode. Station frequency is indicated on display.

#### To Select Band

Press BD/FN button (4) to toggle through radio modes as follows.  
 FM1-->FM2-->FM3-->AM1-->AM2-->FM1.

#### Manual / Seek tuning button (15)

Press this button quickly to activate the Seek mode. The Seek mode will automatically seek up or down the wave band and stop at the next station of sufficient signal strength. Press and hold tuning button for 2 seconds to enter manual tuning mode. The unit will revert back to Seek mode after 10 seconds without use.

#### Manual Station store

Select the desired band and tune to a radio station to be memorized. Choose the preset button memory location span 1-6 into which the station is to be stored and press and hold that preset button for 2 seconds. The station will now be entered into the preset memory. 6 stations can be memorized on each of the FM1, FM2, FM3, AM1, AM2 bands.

#### A.PS - Auto Store function (13)

Press and hold A.PS button for approximately 2 seconds until you hear a beep which confirms the memory function is engaged. The unit will search for six strong stations and automatically store them on buttons 1 - 6. (FM/AM only) You can override the preset station on any button by manually setting a new frequency.

#### Scan function (11)

In Radio mode, press the SCAN button to scan strong stations. At the desired station press the SCAN button to stop scanning.

#### Program Memory Scan

Momentarily press A.PS and the unit will scan for stored stations. Momentarily press it again to stop scanning.



## OPTIONAL HYDROPOOL SURROUND SOUND AUDIO AND DOCKING STATION (continued)

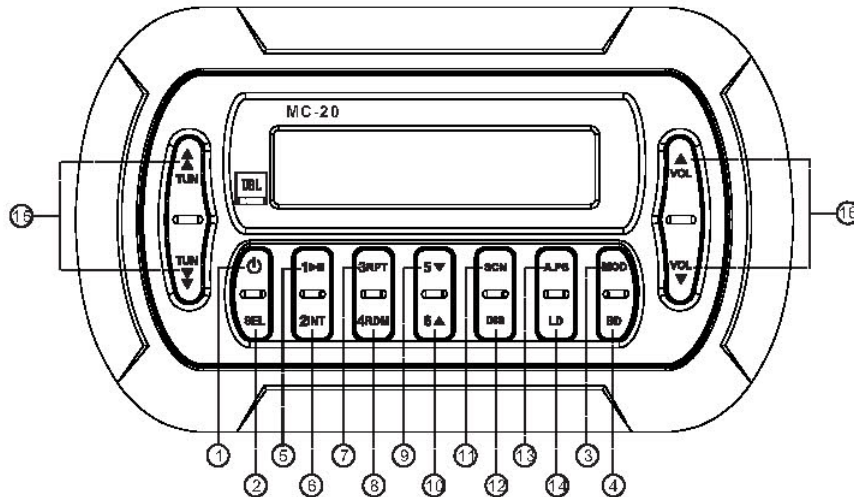

### USB OPERATION

#### USB Operation

With a USB stick connected, press MOD button (3) to select USB mode.

Note: The music in the USB stick must be of mp3 or wma format. The USB drive is for USB drives only. Do not attempt to hook up any other portable media forms as they will not be recognized.

#### Play / Pause button (5)

Push this button to Pause playback. Push it again to resume playback.

#### Intro Scan button (6)

Short push INT to hear the first 10 seconds of each track in the USB. Press and hold INT for 2 seconds to hear the first 10 seconds of each track in the current directory. Simply push INT again to return to normal play mode.

#### Repeat play button (7)

Short push RPT button to play the current track repeatedly. Press and hold RPT for 2 seconds to play all the tracks in current directory repeatedly. Simply push RPT button again to return to normal play mode.

#### Random play button (8)

Short push RDM button to play all the tracks in the USB in a random sequence. Press and hold RDM for 2 seconds to play all the tracks in current directory randomly. Simply push RDM button again to return to normal play mode.

#### Directory UP or Down button (9,10)

Simply push the Directory UP or Down button to select the next or previous directory. If the USB stick does not contain directories, it would play the track at 10- file when you push Directory Down button (9), and play the track 10+ file when you push Directory UP button (10).

#### ID3 Display button (12)

While a MP3 or WMA track is playing, pushing DIS button (12) repeatedly to display the ID3 information in a sequence of: TITLE-->FILE-->ARTIST-->ALBUM-->CLOCK-->-->ELAPSE TIME.

#### Track Up or Down button (15)

Simply press Track Up or Down button (15) to select the next or previous track. Press and hold the button to advance the track rapidly in forward or backward direction.

#### File or Directory Search button (13)

To search file: Short push A.PS button, the push VOL+/- button to search the tracks upward or downward in one track step. At your desired track, press BD button to confirm your selection and it will automatically begin to play the track.

To search directory: Press and hold A.PS button for 2 seconds, then push VOL+/- to search the directory upward or downward in one step directory step. At your desired directory, press BD to confirm your selection. Then search sub-directory and file as above method.

## OPTIONAL HYDROPOOL SURROUND SOUND AUDIO AND DOCKING STATION (continued)

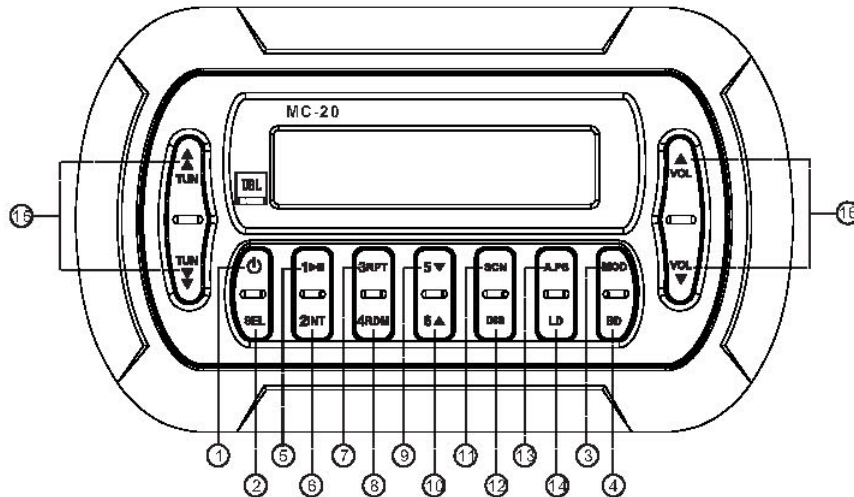

### GENERAL CONTROLS

#### 1. POWER ON/OFF button, MUTE button (1)

With the unit off, press the Power button (1) to turn on the unit. A quick press of the Power button while “on” results in the **MUTE** function. With the unit on, press and hold for more than 2 seconds to turn off the unit.

#### 2. SELECT button (2)

Press SEL button (2) repeatedly to select the desired mode in the following order.

**BASS-->TREBLE-->BALANCE-->FADER-->EQ**

At each feature, press **VOL UP/DOWN** button to adjust to the desired level. If the key or one of the keys is not pressed within 5 seconds, the radio automatically switches into volume control mode. Please note that if **EQ** setting is chosen, then you will not be able to access **BASS** and **TREBLE** functions. This is because the stereo has pre-chosen those levels for you. You may adjust **BASS** and **TREBLE** if **EQ** is in the **OFF** position.

#### 3. VOLUME Control (16)

Press volume up or volume down button (16) to increase or decrease volume. Current volume setting is briefly indicated on the display panel from 00 to 45.

#### 4. MODE Selection (3)

Press **MODE** button (3) to cycle through available program sources as follows:

**Radio-->USB-->AUX-->BT MUSIC**

Note: A valid USB drive must be inserted into the USB port in order for that mode to appear.

#### 5. CLOCK/TIME Adjustment

In Radio mode, press **DIS** button (12) once to display the time.

A. Press and hold the **DIS** button (12) until time flashes on the display.

B. Press **VOL** up (16) to set hour.

C. Press **VOL** down (16) to set minute

D. Press **DIS** button (12) again quickly to accept the adjusted time. If no button is pressed within 5 seconds, then the unit would automatically accept the adjusted time without further intervention from the user.

#### 6. LOUD Control

When listening to music at low volume levels, this feature will boost the bass and treble response. This action will compensate for the reduction in bass and treble performance experienced at low volume. Press the **LD** button (14) once to turn **LOUD ON**, **LOUD** icon would appear on the display panel. Press the **LD** button (14) once again to turn **LOUD OFF**, and **LOUD** icon would disappear from the display panel.

#### 7. Sub-woofer

To turn on the sub-woofer, select **SUB-W** mode by pressing and holding the **SEL** button (2) until **SUB-W** appears on the display panel. Then press **VOL +/-** (16) to switch between **SUB-W ON** and **SUB-W OFF**.

## HOT TUB WATER BALANCE – GENERAL OVERVIEW

### NOTABLE POINTS

- The reliability and longevity of your hot tub support equipment are directly related to how well water quality is maintained!
- The small volume of water in your hot tub is easily affected by the introduction of oils, lotions, perspiration and chemicals. It is imperative that you give your hot tub regular attention to maintain clean, safe and balanced water to prevent premature damage and/or failure (corrosion/calcification) to the support equipment. Maintaining proper hot tub water balance and sanitizer levels is extremely important. Neglected hot water will allow bacteria to quickly spread.
- The mineral content of hot tub water increases due to water evaporation, sanitizers and other chemicals. If the mineral concentration, particularly calcium, becomes too high, the minerals will literally “drop” or precipitate out of the water and deposit on the hot tub walls, plumbing, jets, in the filter and on the heater element.
- It is very important that pH be checked frequently and maintained in the recommended range as indicated in the chart **WATER BALANCE SUMMARY FOR YOUR HOT TUB**
- It is also very important that Total Alkalinity (the ability of the water to resist a change in pH) be maintained in the recommended range as indicated in the chart **WATER BALANCE SUMMARY FOR YOUR HOT TUB**
- Although there may be two identical hot tub models right next door to each other, the maintenance requirements will be different, dependant on such factors as:
  - bather load
  - frequency of use/quantity of bathers
  - different body chemistry
  - sun vs. shade
  - temperature

For these reasons, it is very important to develop proper hot tub water maintenance habits and follow your HydroPool retailer's recommended water maintenance procedures.



**Heater and other component failure due to improper water balance is not covered under warranty.**



### WARNING

#### CHEMICAL HANDLING SAFETY HINTS

- **Never pre-mix chemicals with each other prior to adding to hot tub water.**
- **Add only one chemical to the water at a time.**
- **Always add chemicals to water and not vice-versa.**
- **Chemicals may be corrosive, so handle with care and store in a cool dark place.**
- **Never smoke near chemicals as most are flammable**
- **Ensure any spilled chemicals are carefully cleaned up immediately.**
- **Always have the POISON CONTROL telephone number handy in the event of an emergency.**
- **Keep chemicals out of children's reach**
- **Wear safety glasses and gloves when handling chemicals.**

#### INITIAL WATER FILL & BALANCE

- 1 Make sure the hot tub water is circulating.
- 2 Add a sequesterant (stain and scale controller). Allow water to circulate for an hour before adding anything else to the hot tub water.
- 3 Add a Shock / oxidizing agent .
- 4 Add sanitizing tablets (Bromine or Chlorine) to the dispenser:

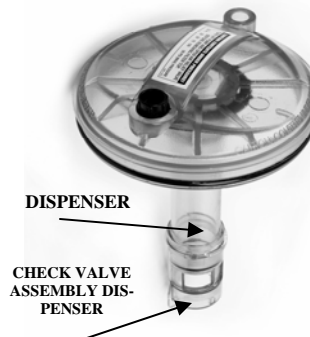

Your HydroPool hot tub comes with a built in bromine/ chlorine dispenser, (located in the lid of the cartridge filter housing), refer to section **CARTRIDGE FILTER** for details on removing and re-installing the lid. Once the filter lid is removed, you'll notice a clear 2.5 cm (1") diameter tube extending from the bottom of the lid.

Expose the large Refill hole at the end of the tube and add 5 or 6 tablets. Do not overfill dispenser as performance will be affected. Turn to expose the largest area and allow water to circulate for 3 or 4 hours before testing level. Adjust to lesser area as necessary to maintain a level of 2 –4 PPM Sanitizer.

Floating dispenser: As above, add 6 or 7 tablets, adjust initially to '5', allow water to circulate for 3 to 4 hours, then test.

The tablets will dissolve slowly over a 10-14 day period, depending on setting, and use of the hot tub.

- 5 Test pH and Total Alkalinity and also adjust accordingly. Expose the large Refill hole at the end of the tube and add 5 or 6 tablets. Do not overfill dispenser as performance will be affected. Turn to expose the largest area and allow water to circulate for 3 to 4 hours before testing level. Adjust to lesser area as necessary to maintain a level of 2-4 PPM Sanitizer.

## GLOSSARY OF COMMON WATER MAINTENANCE TERMS

- 1 **CHLORINE** – in granular, liquid or puck/tablet form, is an oxidant and biocidal agent. It is very effective and fast acting. Recommended chlorine residual level is 3.0 to 5.0 ppm.
- 2 **CHLORAMINES** – a compound formed when chlorine combines with nitrogen or ammonia present in the water. When allowed to go unchecked, it causes eye and skin irritation and is indicated by a strong chlorine odor.
- 3 **ONE-PART BROMINE** – also available in puck/tablet form, is another type of oxidant/biocidal agent, and is introduced into the hot tub water via a brominator. Recommended bromine residual level is 3.0 to 5.0 ppm
- 4 **TWO-PART BROMINE** – composed of a liquid or powder component introduced manually into the water on a weekly basis, and a granular component that is added daily or as the hot tub is used.
- 5 **BROMAMINES** – are formed when bromine destroys nitrogen-bearing organic matter. Unlike chloramines, bromamines don't cause eye irritation, however, when allowed to go unchecked, will cause an objectionable odour.
- 6 **SHOCK** – the practice of adding an oxidizing agent to hot tub water to destroy ammonia, nitrogenous and organic contaminants (chloramines and bromamines)
- 7 **pH** – a logarithmic value expressing the relative acidity or basicity of a substance (such as hot tub water) as indicated by the hydrogen ion concentration. pH is expressed as a number on a scale of 0 to 14, where 0 is most acidic, 1 to 7 being acidic, 7 considered neutral, 7 to 14 being basic, and 14 being most basic. The ideal range for hot tub water is 7.4 to 7.6 ppm
- 8 **pH INCREASER** – raises the pH level of the water.  
**pH DECREASER** – lowers the pH level of the water.
- 10 **TOTAL ALKALINITY (TA)** – the amount of carbonate, bicarbonate and hydroxide compounds present in the water that determines the ability or capacity of the water to resist change in pH. Also known as the 'buffering' capacity.
- 11 **ALKALINITY BOOSTER** – raises the alkalinity.
- 12 **CALCIUM HARDNESS** – the calcium portion of the total alkalinity which represents 70 to 75% of total hardness. Calcium concentrations determine whether water is 'soft' - too little calcium, or 'hard' -too much calcium.
- 13 **CALCIUM BOOSTER** – increases the calcium level.
- 14 **TOTAL DISSOLVED SOLIDS (TDS)** – a measure of the total amount of dissolved matter in the water (calcium, carbonates, bicarbonates, magnesium, metallic compounds, etc.)
- 15 **SEQUESTERANTS (STAIN AND SCALE CONTROLLERS)** – keeps dissolved metals and minerals in the water from attacking the hot tub shell and support equipment components.
- 16 **DEFOAMER** – removes foam build-up from the water surface. At best, this is a temporary remedy, as excessive foam is merely a symptom of improper water balance (typically high organic residue and/or high pH).
- 17 **CARTRIDGE FILTER CLEANER** – degreases and cleans cartridge filters.
- 18 **OZONATOR** – generates Ozone (a gaseous molecule composed of 3 atoms of oxygen) and is injected into the hot tub water for the oxidation of water contaminants.
- 19 **TEST KIT** – used to monitor specific chemical residual or demands in the water. May be in the form of litmus strips or liquid drops.
- 20 **PPM** – abbreviation for 'parts per million', the unit of measurement used in chemical testing which indicates the parts by weight in relation to one million parts by weight of water. Essentially identical to the term mg/L - milligrams per liter.

### WATER BALANCE SUMMARY FOR YOUR HOT TUB\*

SANITIZER (ppm)	MIN	IDEAL	MAX
Chlorine	1.0	3.0 - 5.0	5.0
Bromine	1.0	3.0 - 5.0	5.0
<b>CHEMICAL</b>			
PH	7.2	7.4 - 7.6	7.8
Total Alkalinity (TA)	80	80 - 120	180
Calcium Hardness	150	200 -400	500 -1000

\*National Spa & Pool Institute recommended levels for residential spas/hot tubs

## WATER BALANCE TROUBLESHOOTING

PROBLEM	POSSIBLE CAUSES	SOLUTIONS
Cloudy Water	Microscopic particles too small to filter out.	Test and adjust all water balance elements and add flocculent* to cause the particles to combine together so they can be filtered out. Increase filter cycle time.
High Total Alkalinity High pH levels High Calcium Hardness		Test these water balance elements and adjust to recommended parameters.
Scale (White/Grayish Deposit)	High Calcium Hardness	Test calcium hardness level and treat with sequestering agent* or perform partial drain/refill.
Skin Eye Irritation	Improper pH and/or Total Alkalinity levels	Test water balance and make the appropriate changes.
Excessive Foam	Buildup of body oils or cosmetics	If no water line is present you can try using defoamer* to break up the contaminants and then a clarifier* to help filter them away. If a water line is present the spa may need to be drained and cleaned. Either way, the filter should be thoroughly cleaned by soaking over night in bleach. An oil absorbing sponge can help in preventing this in the future. Increase filter cycle time.
	Laundry detergent residual in swimwear	Prevent by running an extra rinse cycle on washing machine or re-rinse well by hand
	Excess organic contaminants	Some organic matter is prone to causing foamy water as it breaks down in the filter (maple leaves especially). Generally using defoamer* to break up the contaminants, then a clarifier*  To help filter them away followed by thoroughly cleaning your filter will clear up the problem. It may however be necessary to drain and refill your spa if the foaming is quite excessive.
	Low Calcium Hardness	Test calcium hardness and if necessary increase with calciumchloride*
Corrosion/Etching	Presence of metals in water (iron, copper, etc)	Test total alkalinity levels and if necessary increase with sodium bicarbonate*
Discoloured Water (Clear v. turbid water)	Presence of metals in water (iron, copper, etc)	Treat with chelating* or sequestering agent*
Unstable pH	Low Total Alkalinity levels	Test total alkalinity levels and if necessary increase with sodium bicarbonate*
pH resistant to changing	High Total Alkalinity levels	Test total alkalinity levels and if necessary decrease with sodium bisulfate* or muriatic acid*
		* Contact your local Hydropool retailer for specific product recommendation

## ROUTINE HOT TUB MAINTENANCE



### REVIEW CHEMICAL HANDLING SAFETY HINTS

#### DAILY

- 1 Test water, and if necessary, add shock.
- 2 Ensure proper water level is maintained.

#### WEEKLY

- 1 Test pH and Alkalinity. Adjust accordingly
- 2 Top-up chemical dispenser
- 3 Add sequesterant (**stain and scale controller**)
- 4 Remove and spray cartridge filter with garden hose and re-install (**see section CARTRIDGE FILTER**)
- 5 Remove and clean out skimmer basket (**see section CLEANING THE SKIMMER BASKET**)
- 6 Add Shock / oxidizing agent
- 7 Inspect union connections for o-ring and gasket leaks - Tighten if loose
- 8 Clean stainless steel controls as indicated on page 29.

#### MONTHLY

Soak your filter cartridge in a filter cartridge cleaning solution. Rinse thoroughly and, if possible, allow to dry before re-installing. Hydropool recommends purchasing a second filter so that while the first is cleaning, the other is clean and ready to install

#### QUARTERLY

Drain hot tub at least once per quarter and clean the acrylic shell surface with a non-abrasive cleaner designed specifically for acrylic surfaces. **See sections CHANGING THE HOT TUB WATER and DRAINING YOUR HOT TUB**

#### CLEANING THE SKIMMER BASKET

- 1 Activate the **STANDBY/DRAIN ASSIST** mode
- 2 Remove the skimmer basket by pulling the weir door forward, and pulling the basket up and towards the front
- 3 Remove debris from basket. (**Note: Avoid hitting the basket against objects to knock debris loose as this may damage the unit**)
- 4 Reinsert basket
- 5 Take the system out of **STANDBY/DRAIN ASSIST** mode, and as the pump begins to operate, monitor water flow over the weir door to assure that it is free floating



## CARTRIDGE FILTER

The cartridge should be cleaned every two to four weeks, depending on the amount of use. Signs that the filter requires cleaning include:

- **Reduced jet power**
- **Hazy gray water**
- **Rattling noise in the pump or filter**
- **Heater not working**

## REMOVAL

- 1 Activate the **STANDBY/DRAIN ASSIST** mode.
- 2 Remove the filter cover and open the small, black air vent / bleeder valve on the top of the filter lid.
- 3 Lift the gray lock tab to disengage and turn the locking ring counter clockwise.
- 4 Pull the filter lid upwards, and lift the cartridge elements straight up and out of filter housing.
- 5 Separate the inner and outer core from each other by pushing the inner core out.

## CLEANING

- 6 With a garden hose and spray nozzle, hose off the cartridge element, ensuring to carefully separate every pleat.
- 7 To remove collected lotions, body oils, etc. soak the cartridge in warm water and a filter cleaning/emulsifying compound (**available at your HYDROPOOL retailer**).
- 8 A cleaning cylinder may be purchased from your HYDROPOOL Hot tub Retailer.
- 9 Rinse thoroughly and dry before replacing.
- 10 HydroPool recommends purchasing a spare filter cartridge so that you always have a clean substitute ready to rotate.
- 11 After the element has dried - if necessary, lightly brush between pleats with a fine paint-brush to remove remaining dirt particles.



**Do not use a wire brush or other device to clean cartridge element. Do not put in dishwasher or washing machine.**

## RE-INSTALLATION

- 12 Place the cartridge filter back into the filter housing.
- 13 Replace the filter housing lid, pushing it down to seat, ensuring that the lid o-ring does not become twisted.
- 14 HydroPool recommends that the lid o-ring be lubricated with a non-petroleum based lubricant (ie. Silicone gel) when it becomes dry. This will help to prevent twisting and pinching as the lid is installed, and significantly increase longevity of the o-ring.
- 15 Install the filter lock-ring, turning clockwise until the lock tab snaps into place.
- 16 Close the air vent/bleeder valve.
- 17 Take the system out of **STANDBY/DRAIN ASSIST** mode.
- 18 When the pump starts circulating on low speed, it will be necessary to release trapped air in the filter. Carefully loosen the air vent/bleeder valve counter-clockwise until there is the hissing sound of air escaping. Once there is a steady stream of water, close the vent valve, ensuring that the o-ring does not become pinched.

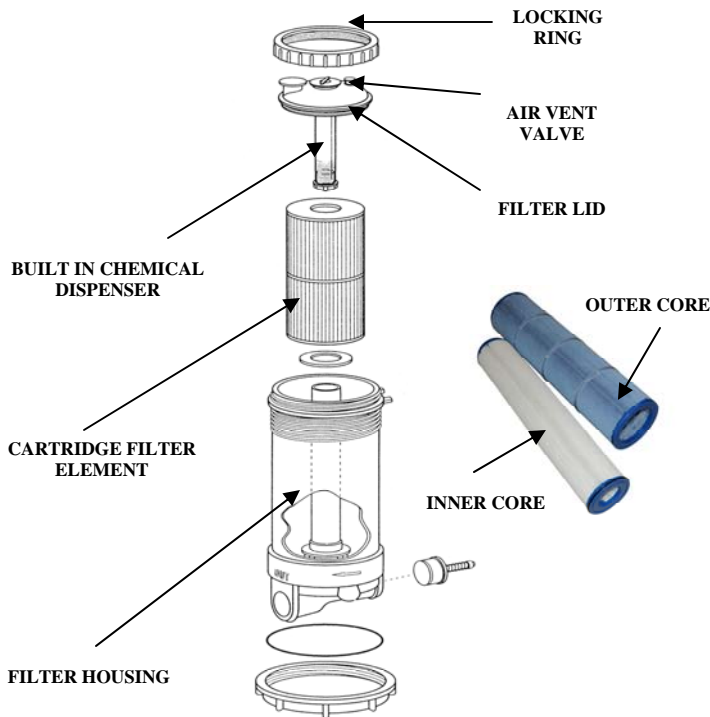

## CLEANING THE ACRYLIC SURFACE

The acrylic surface can be cleaned and polished using a soft cloth and acrylic cleaner, available at your HydroPool retailer.



- **Important: Do not use detergents - the remaining residues will adversely affect water chemistry, making it difficult to maintain proper water balance**
- **Do Not use abrasive cleaners – damage to the acrylic surface will occur.**

## SAFETY HARD COVER

When a hot tub is uncovered, over 90% of heat is lost from the water surface. This evaporation also affects the chemical balance and could create humidity problems indoors. HYDROPOOL Safety Hard Covers are engineered for maximum thermal efficiency and appearance. They are hinged in the middle for easier handling, and the zip fastener allows the tapered foam inserts to be changed if damaged. The skirt of the safety hard cover hugs the lip of the hot tub for a tight fit. The handles are placed so that even one person can easily carry a large cover. The locks, with one part fastened to the deck or skirt, prevent small children or animals from entering the hot tub.

Do not drag the safety hard cover across the hot tub or decking. Fold the cover first, then lift by the handles. Standing on the hardcover could cause the tapered foam inserts to crack, which will lead to water absorption.

## NEVER LEAN OR STAND ON YOUR HARDCOVER.

The cover should be cleaned at least twice a year with a vinyl moisturizer and protector.

## CHANGING THE HOT TUB WATER

A hot tub should be drained every 8-12 weeks, depending on size and amount of use. If your hot tub is used daily or by a large number of bathers, the water should be drained more often. One method to determine the approximate length of time between water changes is to divide the water volume (in liters) of your hot tub by 13.5 and then divide by the average number of bathers each day.

### Formula

$$\left( \frac{\text{Volume of water in litres}}{13.5} \right) \div \left( \frac{\text{Average daily bathers}}{\text{Days between water changes}} \right) = \left( \text{Days between water changes} \right)$$

### EXAMPLE:

1000 liters divided by 13.5 divided by 2 = 37 days. The hot tub water must be changed when the amount of dissolved solids becomes excessive, and is usually indicated by "gray" or dull looking water.

## DRAINING YOUR HOT TUB HYDROPOOL EXCLUSIVE QUICK-DRAIN™ & FILL REFER TO DIAGRAM

### OVERVIEW

- Requires the use of 2 garden hoses - drain hose and fill hose
- While first garden hose is draining old water from hot tub...
- ...second hose is used to wash down interior surface of the hot tub and for fresh water fill.

### REFER TO FIGURE 1 & FIGURE 2

- 1 Locate nearest drain facility (**Check your local bylaws**).
- 2 Put the hot tub control system into **STANDBY/DRAIN ASSIST\*** mode. The system will automatically exit Standby Mode after 1 hour and resume normal operating functions.
- 3 Remove the skimmer basket so that the hole beneath it is accessible, and insert the #10 rubber expansion plug provided.
- 4 Attach garden hose to hose bib located on plumbing line beside the hot tub control system.
- 5 Run garden hose to drain location.
- 6 Open hose bib.
- 7 Close filtration pump return gate valve next to the hose bib (this directs the water out the drain hose).
- 8 Activate the filtration pump.
- 9 Monitor the hot tub while it drains.
- 10 Use the second garden hose to wash down interior surface as the hot tub continues to drain. A sponge may also be used to wipe down the interior surface.

- 11 To completely flush the old water from the plumbing lines: allow fresh water to fill into the foot-well area while the old water continues to be pumped out. Always keep at least 10cm (4 in.) of water in the foot-well so that pump 1 remains primed.
- 12 When the water from the drain hose turns clear (indicating fresh fill water), flush is complete.
- 13 Turn OFF the filtration pump.
- 14 Close the drain-hose bib on the hot tub plumbing line and continue filling hot tub with fresh water.
- 15 Place cover on hot tub (to avoid splash-out).
- 16 Open filtration pump return gate valve.
- 17 Press any button on the topside control panel (other than the pump 1 button) to take the system out of **STANDBY/DRAIN ASSIST\*** mode. Filtration pump and the heater will activate to circulate and heat the water while filling continues. This also reduces the possibility of an airlock occurring.
- 18 Continue adding fresh fill water until level is approximately 19mm (3/4 in.) from the top of the skimmer opening.
- 19 Once fill is complete, remove the #10 rubber expansion plug from the bottom of the skimmer housing.\*\*
- 20 If the filter housing was opened to replace the cartridge filter, it will be necessary to release trapped air from the filter housing by carefully loosening the small black air vent/bleeder valve located on the top of the filter housing. When water begins to escape close the air vent valve.
- 21 In the unlikely event of a pump air lock (pump 1 is operating but there is no water movement from the jets), refer to section **PUMP PRIMING/RELEASING AN AIR LOCK**

\*\* It may be necessary to put system into **STANDBY/DRAIN ASSIST\*** mode in order to remove plug.

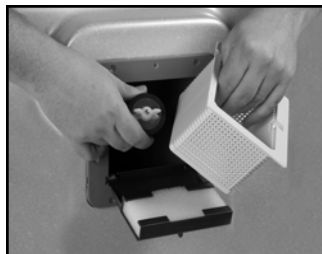

FIGURE 1



FIGURE 2

## WATER SOFTENERS

Never fill a hot tub with water from a water softener, as it could adversely effect the water chemistry, making it difficult to maintain proper water balance. If you live in an area with hard or soft water, give careful attention to your Calcium Hardness level. Topping up with soft water is acceptable.



## HYDROPOOL EXCLUSIVE QUICK-DRAIN™

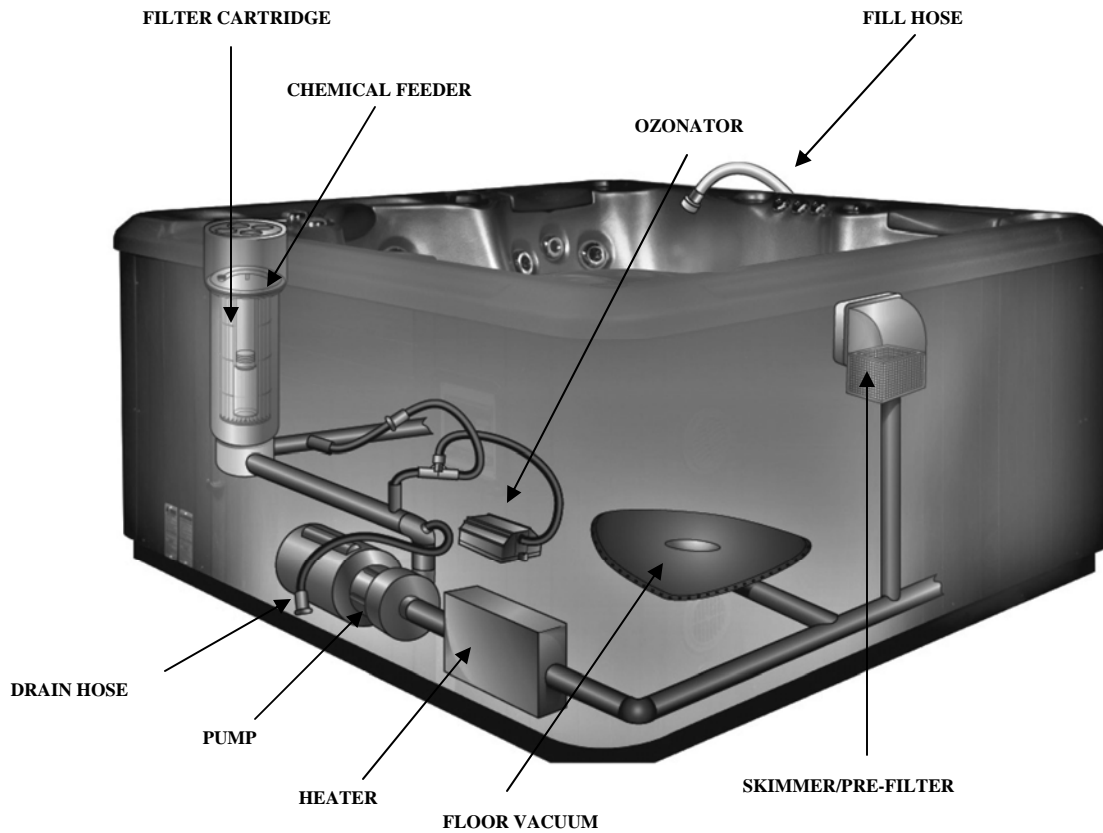

### THE SELF-CLEANING MODE INDICATOR

This worry-free indicator is located on the topside control display. The display will indicate “**SCLn**” on the display ensuring that the Self-Clean and Eco Heat Systems are both functioning and reassuring you of your family’s safety and protection.

## CABINET WING-LOCKS

The high quality wing-locks provided on your Hydropool Hot Tub cabinet not only firmly secure the equipment access panel, they also serve as convenient handles for removal and replacement. In order to maintain optimum performance and extended life, Hydropool recommends lubricating twice annually with a silicone based lubricant.

**RECOMMENDED PRODUCT:** Super-Lube silicone based lubricant (or equivalent) available at major retailers.



**CAUTION:** Do not use a petroleum based lubricant, as this will cause premature deterioration of the lock seal.



LUBRICATION POINT

## PROTECTING YOUR CABINET WOOD FINISH

Some HYDROPOOL hot tub cabinets are made from Western red cedar and are factory stained. Once stained, cedar weathers well, and with proper care will maintain its beauty for many years. In order to maintain the translucent finish and to enhance the wood grain beauty staining must be performed on a regular basis. These protective finishes stabilize the wood grain and build a durable, breathable water-repellent barrier between the wood surface and the elements. These products are available from your local building supply center..

## WINTERIZING YOUR HYDROPOOL HOT TUB

In the event that you do not wish to use your hot tub year-round, it is very important that you properly winterize to protect against damage from freezing. Your HYDROPOOL retailer can perform this service for a nominal fee. If you choose to winterize your hot tub yourself, please follow the directions outlined below:

- Drain the hot tub entirely see section - **DRAINING YOUR HOT TUB**

- Remove and clean the cartridge filter element see section - **CARTRIDGE FILTER**

- Using a wet/dry utility vacuum, remove remaining water from the jet openings, filter cartridge housing, and footwell.

- Either pour or use a turkey-baster where necessary to add potable biodegradable RV antifreeze to areas such as pump wet end, jet channels, filter housing, blower channels.

**DO NOT USE AUTOMOTIVE ANTIFREEZE.**

- **Important:** mixing potable biodegradable RV antifreeze with water significantly reduces its ability to protect against freezing. Therefore, it is very important ALL water is removed from the hot tub plumbing before adding.

- Add potable RV antifreeze to the holes in the bottom suction/drain to prevent any trapped water in the false floor from freezing and damaging the hot tub shell.

- Turn pump on for only a few seconds to circulate the antifreeze.

- Unthread and disconnect all unions in the support equipment area. Remove lowest winter drain plug on pump face plate. Repeat for all pumps, where applicable.

- Cover exposed plumbing connections with plastic bags and duct tape.

- Where practical, disconnect hot tub support equipment and store in a dry heated area.

- Install the safety hardcover, and cover the entire hot tub with a tarp to prevent premature weathering of the cabinet and the safety hard cover.

- Remove snow build up regularly to prevent damage to the safety hard cover.

- It is assumed that your HYDROPOOL hot tub has been properly installed on a reinforced concrete pad to eliminate lifting of the hot tub due to hydrostatic ground water pressure.



**If you are not 100% confident that your hot tub is properly winterized, please consult your authorized HYDROPOOL Hot Tub Retailer. Caution recommends that an authorized Hydropool Retailer winterize your hot tub in the initial year. Damage as a result of freezing is not covered by the warranty.**



**DRAIN PLUG LOCATIONS**

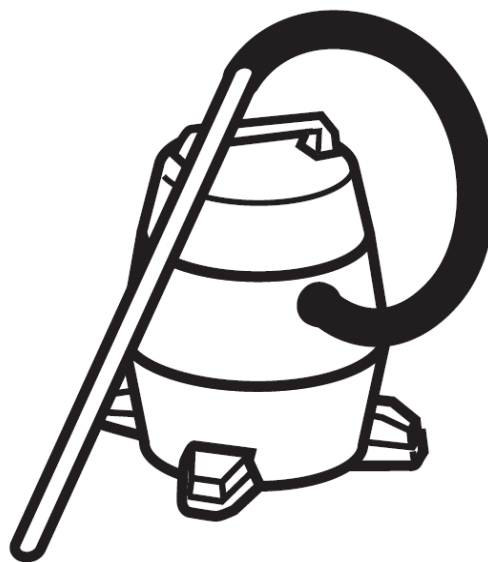

## GENERAL TROUBLESHOOTING

### WHAT TO DO IN THE EVENT OF... ...POWER FLUCTUATIONS

The power supply into your home is, for the most part, fairly consistent.

However, when local power demand is high, there is a tendency for the voltage entering your home to drop (sometimes significantly) or fluctuate.

This condition is referred to as a 'brown-out'. Although safeguards have been built into the system to protect against this condition, supply voltage may drop low enough, if even for a second, to cause the system to display a 'ghost' message. Should this occur or if the display shows partial messages, try resetting the system by turning power to the hot tub off, waiting a few minutes, then turning power on again. If this does not reset the system, contact your local HydroPool retailer or service organization.

### ...POWER FAILURE OR SYSTEM FAULT DURING COLD WEATHER CONDITIONS

If your control system will not reset, (ie. GFCI trips) or if your pump will not circulate for any other reason, place a low wattage space heater under the cabinet in the equipment area. This will delay the risk of freezing while a service appointment is scheduled.



**Always follow the manufacturers instructions when locating and placing a portable electric space heater into service. Ensure that safe clearance to combustible surfaces is maintained. Do not leave unattended.**

### NOTES: